

CMT ORANGE TOOLS®

CATALOGUE 2024 ENGLISH EDITION

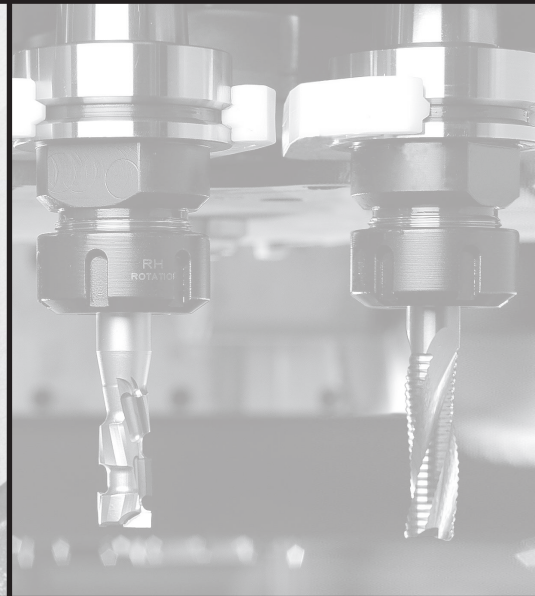

Maximize Your HW Saw's Performance

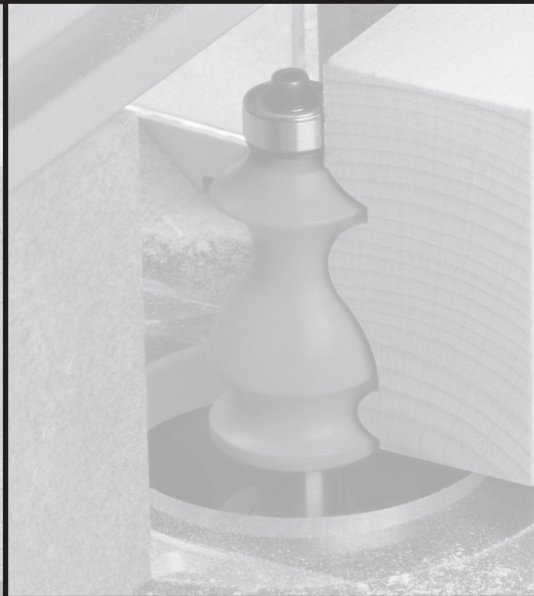
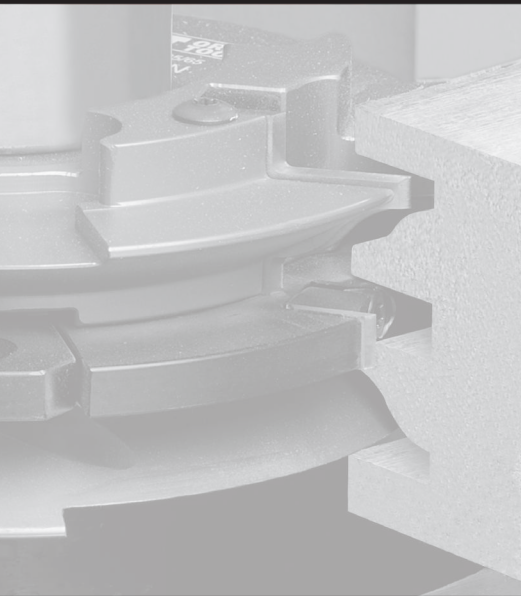

BLADE RANGE	ORANGE CHROME®	XTREME	INDUSTRIAL		ITK PLUS®
PERFORMANCE	★★★★★	★★★★★	★★★★★	★★★★★	★★★
PACKAGING	CARTON BOX + COLORED LABEL		CARTON BOX	CARTON BOX + COLORED LABEL	PLASTIC CLAMSHELL
STEEL PLATE	LASER-CUT PREMIUM QUALITY STEEL PLATE BODY Made with 46-48 HRC premium quality harmonic steel from Germany and laser-cut to perfection providing tighter tolerances translating to longer life and accurate cutting ability.			LASER-CUT HIGH QUALITY STEEL PLATE BODY Made with 44 HRC high quality steel and laser-cut to ensure longer life and precision cutting.	
EXPANSION SLOTS	LASER-CUT HEAT EXPANSION SLOTS Engineered to allow the blade to resist deformation from increases in temperature due to cutting applications and centrifugal forces.				
SOUND DAMPENING SLOTS	LASER-CUT SOUND DAMPENING SLOTS POLYMER-FILLED Slots filled with sound-dampening polymer reduce vibrations and noise by 25% compared to blades without it.*	LASER-CUT SOUND DAMPENING SLOTS Slots reduce vibrations and noise by 10% compared to blades without it. *This feature improves cut quality and extends blade life. *In full compliance with National Noise Emission Standards and Regulations.			
TENSIONING RING	TENSIONING RING A visible tensioning ring on blade body provides stability during the cut and perfect concentricity during rotation. For improved performance, tensioning is fine-tuned according to machine/application.			✗	✗
BRAZING	TRI-METAL BRAZING Silver-Copper-Silver Tri-Metal Brazing prevents carbide from breaking during the cooling process and allows teeth to withstand high stress and impact especially when cutting harder woods and composite materials.	SILVER BRAZING Silver Alloy Brazing prevents carbide from breaking during the cooling process and allows teeth to withstand high stress and impact especially when cutting harder woods and composite materials.			
CARBIDE TEETH	INDUSTRIAL CHROME CARBIDE Cutting teeth are made from a specially formulated chrome carbide which stays sharper longer by reducing cutting edge abrasion, improving cut quality and tool life.	INDUSTRIAL SINTERHIP HI-DENSITY CARBIDE The SINTERHIP sintering process (Hot Isostatic Pressing) uses high temperature (up to 3500°F) and high pressure (up to 1500 psi) to fully consolidate carbide thereby resulting in a porosity-free product ensuring longer cutting life over traditional carbide and less risk of breakages.			
SHARPENING	PRECISION MIRROR FINISH SHARPENING Each tooth is precision ground on a multi-axis CNC machine creating perfect edge angles that provide extra-clean cutting performance and extended life. Featuring less than 0.25 µm Rmax in edge roughness.	PRECISION SHARPENING Each tooth is precision ground on a multi-axis CNC machine creating perfect edge angles that provide extra-clean cutting performance and extended life. Featuring less than 0.35 µm Rmax in edge roughness.		Shear Angle Sharpening The shear angle grinding, on the front face of the teeth, reduces the required cutting force thereby allowing for smoother cutting.	
COATING	ORANGE CHROME® COATING - Protects the tool against corrosion, rust and accumulation of resin and residues. - Guarantees longer tool life. - Lower power absorption by motor. - Smoother blade movement throughout cutting operation. - Tool maintenance is fast and easy.	HARD LAQUERING Protects against corrosion and rust.			ORANGE SHIELD® NON-STICK PTFE COATING - Protects against corrosion and rust. - Reduces resin and residue build-up. - Reduces overheating and blade drag. - Improves performance and cutting life.
BALANCING	CMT XTREME BALANCING™ This system allows for extremely accurate dynamic balancing of the blade, several orders of magnitude above and beyond that which is currently available in the marketplace. *TRADEMARK & INT. PAT. PEND.	✗		✗	✗
KERF	FULL KERF/ THIN KERF	FULL KERF			THIN KERF

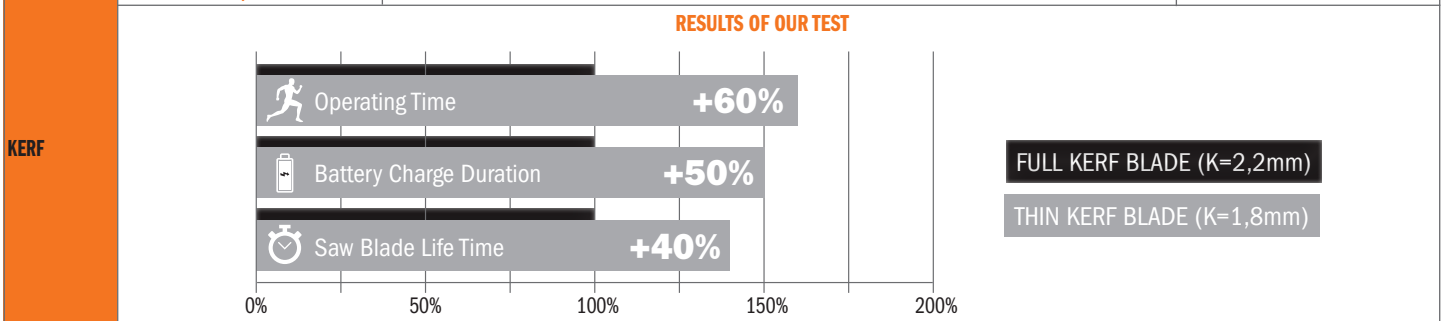

CONSTRUCTION



10

DEMOLITION



11

CONTRACTOR



14-15

MULTI-RIP



16-19

RIPPING



20-23

RIPPING & CROSSCUT



24-27

FINISHING



28-31

FINE FINISHING

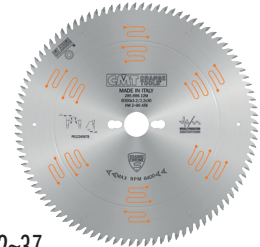

32-37

ULTRA FINE FINISHING

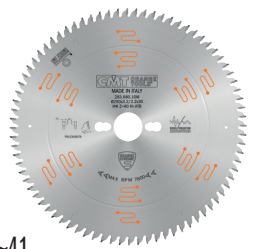

38-41

LAMINATED & CHIPBOARD

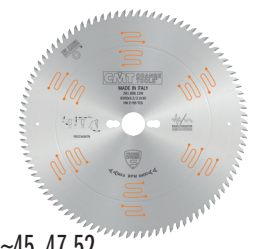

42-45, 47, 52

LAMINATED & HPL



46

PANEL SIZING & DPX



48-49

SCORING & DP SCORING



50-52

DADO



64-65

GROOVING

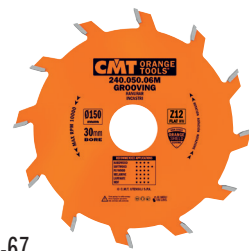

66-67

GROOVING SYSTEM & BISCUIT JOINER



68-69

NON-FERROUS & PLASTIC



54

NON-FERROUS & MELAMINE



55

NON-FERROUS & MELAMINE

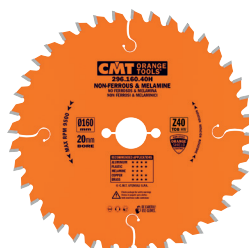

56

NON-FERROUS & MELAMINE ITK®



57

HSS - METAL & STEEL



58-59

HSS - METAL & STEEL (TiCN)



59

METAL & STEEL



60-61

STAINLESS STEEL



62

ANGLE GRINDER



12

DP - ULTRA-HARD & MULTI-MATERIALS



13, 53

SOLID SURFACE & PLASTICS



63

CLEARING GRASS, BUSHES, SMALL TREES



70

WOOD

NON-FERROUS

METAL & STEEL

MULTI-MATERIALS

NEW PRODUCTION FACILITY IN UDINE, ITALIA

We are honored to announce the appointment of Piergiorgio Pozzo as Head of the Saw Blade Division at our new, highly technological production plant, based in Udine.

Mr. Pozzo's experience stems from a long-standing commitment to and success in the development of high-performance industrial blades.

Thanks to a rich and extensive knowledge in the field, Mr. Pozzo and his team have successfully patented a brand-new saw blade line of outstanding quality.



QUALITY ACCORDING TO CMT

Quality can take on different meanings, at times it may relate to the appearance of a product, other times to the number of features or the materials used to make it and so on. Circular saw blades are technical items, tools dedicated to the realization of intermediate workings that if carried out impeccably, enable the manufacturing of the highest-quality finished products with the best production efficiency. Based on this principal, CMT manufactures saw blades using the functional quality concept, this being that every detail of the saw blade, from its design to the choice of materials to its manufacturing cycle, is finalized to give the best performance in the true-life use of the tool. As such, the features of our saw blades are always functional and are found on the product only if and when they bring a true benefit to reaching the established performance target. Should any of the saw blade features fail to do so they will be purposely omitted; the same applies to the tools' manufacturing work cycle which in turn makes it possible for CMT to focus its resources and on what really represents value for the user. The quality embedded in our products is the result of a school of thought which is shared and embraced by the people who make them, and this culture is relentlessly cultivated and improved. Quality at CMT also means respect for people and the Earth.

STEEL PLATE

The body of a blade is an integral part of blade design; cutting quality and longevity depend on it. We use only the highest quality steel available, so durable and tough that it will not only withstand heavy workloads, but also be flexible enough to bend without breaking.

LASER CUT

All our blanks are laser cut; this allows us to use harder harmonic steels for the blade bodies, which in return generates extremely rigid and stable saw blades, guaranteeing perfect flatness. In addition, we are able to engineer quieter tools using a very narrow laser beam to cut expansion and vibration dampening slots.

EXPANSION SLOTS

Engineered to allow the blade to resist deformation from increases in temperature due to cutting applications or centrifugal forces.

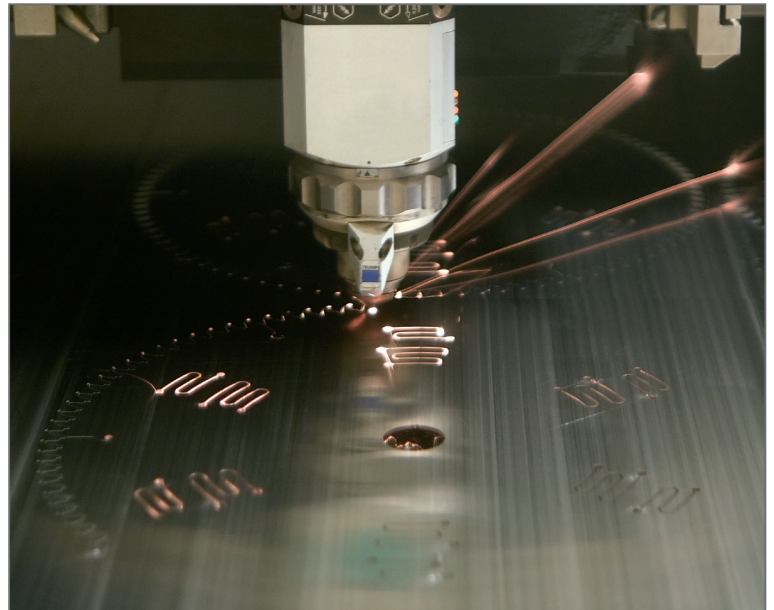

LASER-CUT SLOTS FILLED WITH SOUND-DAMPENING POLYMER

Slots filled with sound-dampening polymer reduce vibrations and noise by 25% compared to blades without it (only the "Orange Chrome" series feature polymer-filled sound dampening slots). This feature improves cut quality and extends blade life.

In full compliance with National Noise Emission Standards and Regulations. (Expansion slots not enhanced by polymer filling, reduce vibration and noise by 10%).

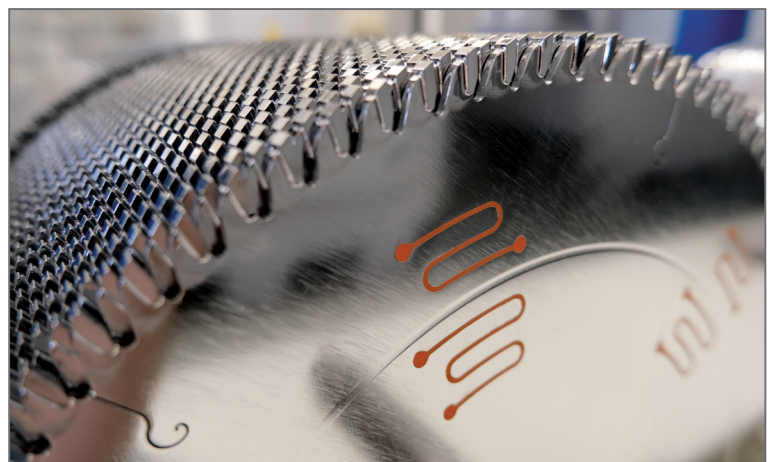

CMT XTREME BALANCING*

* TRADEMARK & INT. PAT. PEND.

This system allows for extremely accurate dynamic balancing of the blade, several orders of magnitude above and beyond that which is currently available in the marketplace.

Each blade undergoes rigorous assessment and only in the event that micro imbalance is detected will the appropriate correction holes be applied.

You may find 1 to 5 micro balancing holes on your blade, depending on the degree of micro imbalance (fig.1). When in perfect balance, a single incision will appear on the blade as proof of balance (fig.2).

These holes will have no effect on the technical properties of the blade during use (such as an increase in noise**, chip build-up at the correction site, etc.).

This translates to precise cutting, longer blade life, reduced vibration and noise, and less wear and tear on your machine components.

**Results are based on tests conducted by an independent laboratory. These results are available for download on our website.

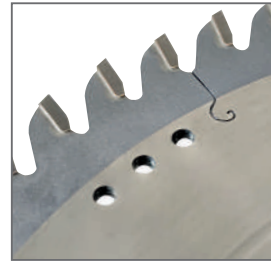
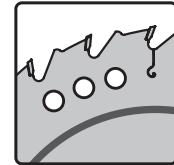

Fig. 1 Example of balancing holes.



Fig. 2 Example of inspected blade already in perfect balance.

**CMT XTREME
BALANCING**



TENSIONING RINGS & FLATTING

To ensure maximum performance, flattening and plate tensioning processes are performed. Every single blade is subject to a flattening process in order to achieve the highest flatness tolerance. The blade body then undergoes tensioning in order to enhance stiffness and stability. A well-marked and visible ring is applied to the blade body by means of compression and with a predetermined force linked to the intended application and working conditions of each blade.

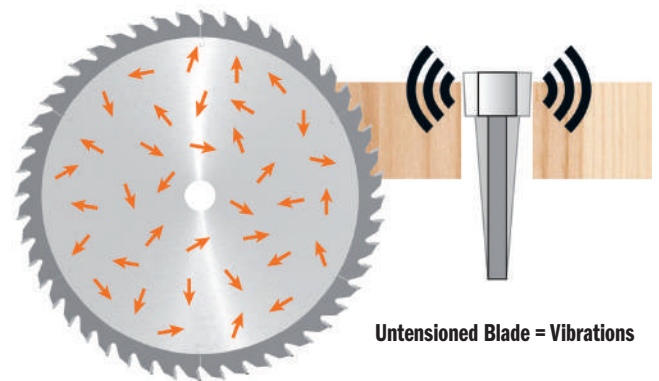
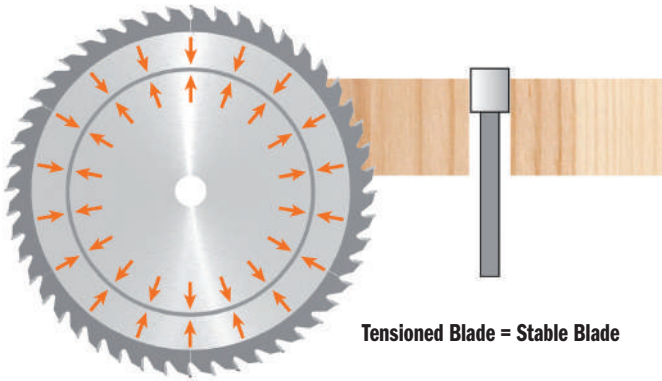

CARBIDE TEETH

Tips require optimum quality carbide. Different applications call for different grades. Our Research and Development Team has evaluated and tested carbide grades and tracked their yield on performance both in house and in the field. We have access to the widest range in the world and only use top premium quality carbides.

TRI-METAL BRAZING

Brazing is the process of attaching a hard metal plate to the steel body of the blade. This is performed by using a bonding metal, which once melted, acts as a binder between the two parts. The bonding material used for brazing is a trimetallic alloy formed by silver, copper and silver, which not only serves to effectively attach the two parts together but whose fundamental properties create a shock-absorber effect protecting the cutting edges during routing operations.

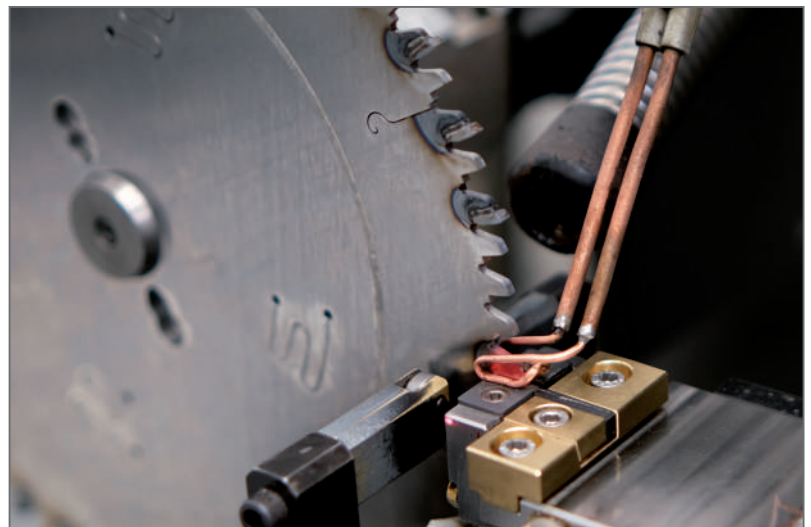
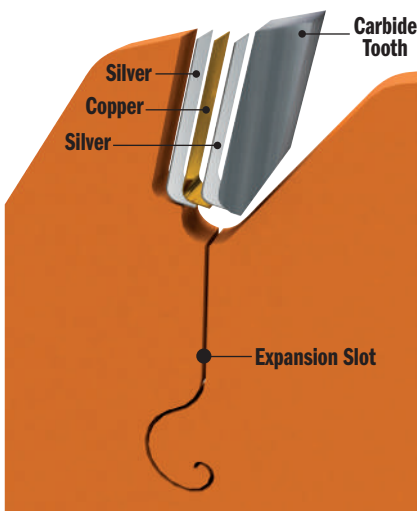

CMT Orange Tools

SHARPENING & CUTTING ANGLES

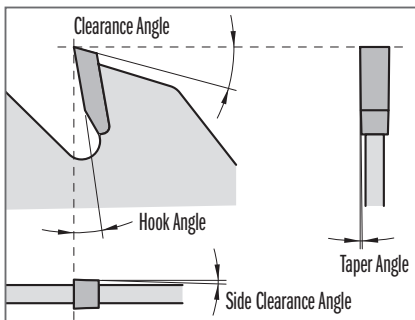

Sharpening is imperative to the production process of the blade and equally important with respect to the project in mind and material in use. Fully automated and numerically controlled grinding machines tooled with extra-fine-grained diamond wheels allow any type of angle and shape of the tooth. The right choice of these parameters will guarantee cutting edge lifetime and ultimately the best finish on the finished part.



COATING

Quality coatings can be extremely effective in certain applications. CMT uses the following:



ORANGE SHIELD® COATING: a registered and trademarked non-stick protective coating bearing our characteristic orange color. A technopolymer (P.T.F.E. is spray-applied to the blade body then baked to enhance its protective properties. Chemical compounds cannot attach this coating, it remains insoluble in water and solvents, is completely non-stick and diffuses and disperses heat.



ORANGE CHROME® COATING: this is a coating composed of a thin layer of chromium, which is electrolytically deposited on the blade in order to increase wear resistance when in contact with highly abrasive material. Surface hardness increases considerably, guaranteeing long-life and incredible resilience to corrosion and rust.

LASER MARKING & SCREEN PRINTING

All CMT blades are identifiable by means of a latest generation indelible laser marking or multicolored screen-printing, a sophisticated automated technology that guarantees striking and versatile results.

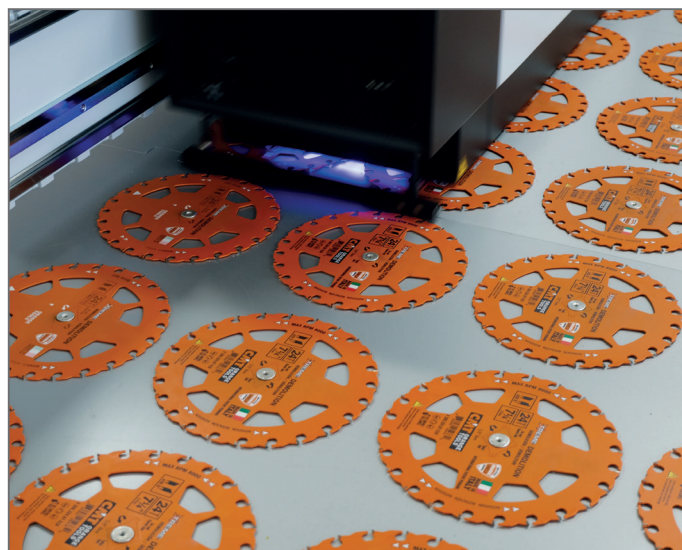

FINAL TESTING AND QUALITY CONTROL

Following design and manufacturing phases, each new model is tested to ensure maximum performance during the work phase. The entire production process is subject to meticulous quality controls using conventional and sophisticated measuring system.



NEW PACKAGING

- Blade packaging is made from strong and sturdy cardboard, reusable and environmentally friendly.
- Package information updated in 12 languages.
- New colored labels offer useful technical information such as application, materials and machine compatibility.



HOW TO CHOOSE A BLADE IN THE NEW CMT CATALOGUE

1

WHAT'S THE MATERIAL YOU WANT TO CUT?

- WOOD**
- NON-FERROUS**
- METAL & STEEL**
- MULTI-MATERIALS**

See table on page 5

2

WHAT'S THE APPLICATION?

- RIPPING
- RIPPING & CROSSCUT
- FINISHING
- FINE FINISHING
- ULTRA FINE FINISHING
- etc

See table on page 5

3

WHAT ARE THE PERFORMANCE EXPECTATIONS?



4

WHAT MACHINE ARE YOU USING?

BASED ON YOUR MACHINE, CHOOSE THE APPROPRIATE BLADE:

- DIAMETER (D)
- BORE (B)

SUGGESTIONS FOR CHOOSING THE RIGHT BLADE:

HOOK ANGLE α

- Wood, Solid Surface ($\alpha = 10^\circ \sim 25^\circ$)
- Chipboard, MDF, Plywood, Laminate, Plastic ($\alpha = 5^\circ \sim 15^\circ$)
- Chipboard, MDF, Non-Ferrous, Metals ($\alpha = 0^\circ \sim 10^\circ$)
- Metals, Non-Ferrous, Plastic, Laminate ($\alpha = -5^\circ \sim -15^\circ$)

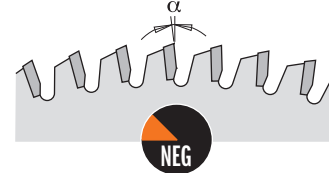
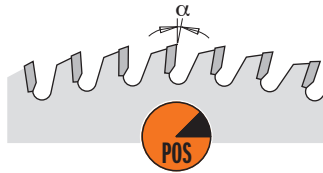

TEETH SHAPE

- Wood, Chipboard, MDF, Plywood

- Laminate, Chipboard, MDF, Plywood, Plastic TRESPA®

- Metals

- Special Application/Materials

FLAT

ATB

(Hi-ATB, ATB+SHEAR)

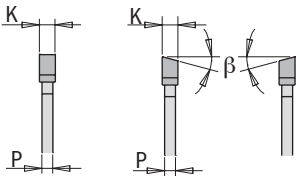

TCG

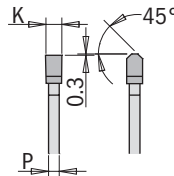

FFT

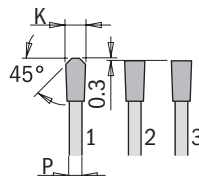

FWF

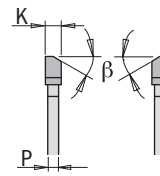

HDF

- FLAT+ATB**
- CO+FLAT**
- MTCG**
- MATB**
- HR**

SUGGESTIONS FOR BLADE USE:

In order to achieve the best cut possible, that is without modifying the predetermined angle of entry/exit, it is important that the portion of the blade (**H**) which extends beyond the workpiece during the cut, be close to equal to the height of an entire tooth (approx. 8/10mm). To improve the finish, it is possible to make small adjustments by increasing or decreasing this height.

The number of teeth simultaneously engaged in cutting the material (**Teeth Cutting or Z_p**) must be constant as the thickness (**S**) of the material varies.

As with $Z_p < 3$, the cutting quality is not guaranteed.

With the same diameter, and when cutting thicker material, ensure to use a blade with less teeth (or with a greater Pitch **P**) or vice versa ($S = [P \times Z_p] / 1.414$).

Thin blades are suitable for thinner materials. They also require less power during operation, and are ideal for battery-operated machines.

Thick blades, which are more robust, are suitable for precision cutting in thicker materials but obviously require more power.

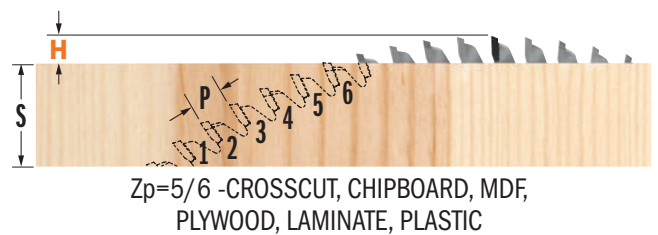
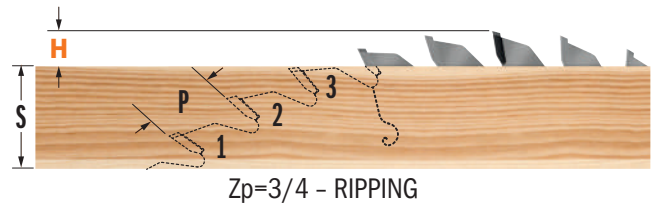

The blade Pitch (**P**), or the distance between each tooth, is calculated in the following way:

$$P = \frac{D \times 3,14}{Z} \quad \begin{matrix} D = \text{Blade Diameter (mm)} \\ Z = N^\circ \text{ of Teeth} \end{matrix}$$

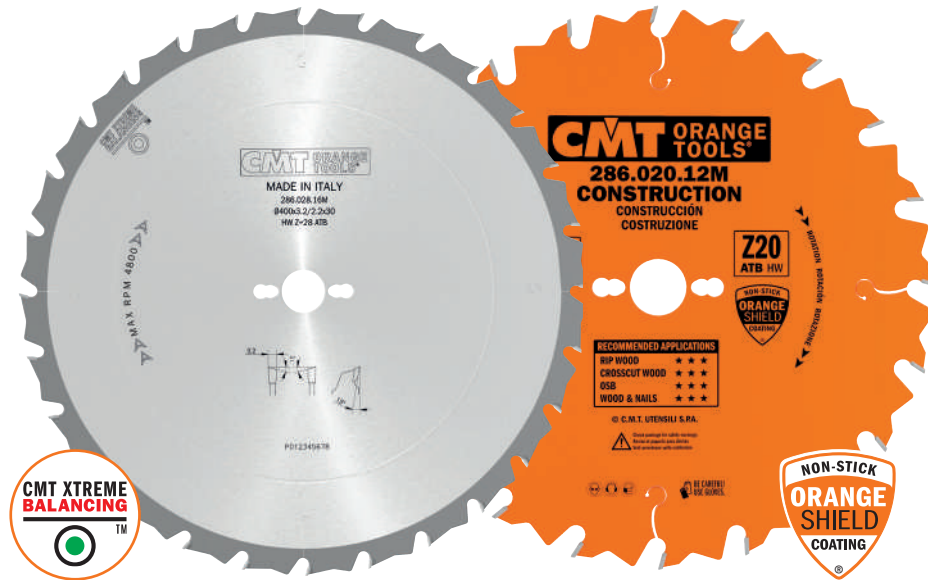

286



WOOD

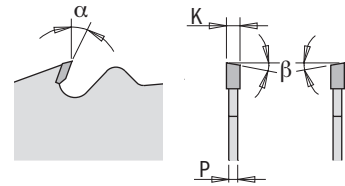

Images are not in scale with each other.

MACHINES



Blade diameter compatibility is contingent on machine type.

APPLICATIONS

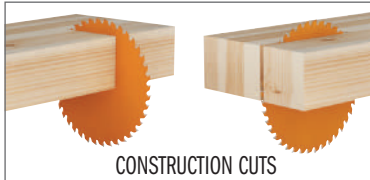

MATERIALS

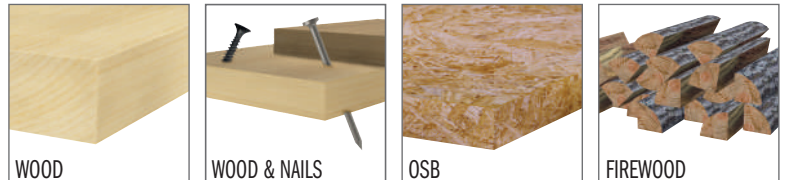

For specific details regarding suggested materials, please check blade label.

286 INDUSTRIAL



D mm	B mm	PIN HOLE	Z	K mm	P mm	α	β	Box	ORDER NO.
250	30	COMBI3	16	2,8	1,8	15°	5° ATB	5	286.016.10M
300	30	COMBI3	20	2,8	1,8	15°	5° ATB	5	286.020.12M
300*	30	COMBI3	48	3,2	2,2	15°	10° ATB	5	286.048.12M
315	30	COMBI3	24	3,2	2,2	15°	5° ATB	5	286.024.13M
350	30	COMBI3	24	3,2	2,2	15°	5° ATB	5	286.024.14M

* Without limiter

286 XTREME



D mm	B mm	PIN HOLE	Z	K mm	P mm	α	β	Box	ORDER NO.
400	30	COMBI3	28	3,2	2,2	15°	5° ATB	1	286.028.16M
450	30	2/10/60	32	3,8	2,8	15°	5° ATB	1	286.032.18M
500	30	2/10/60	36	3,8	2,8	15°	5° ATB	1	286.036.20M
550	30	2/10/60	40	4,2	3,2	15°	5° ATB	1	286.040.22M
600	30	2/10/60	40	4,2	3,2	15°	5° ATB	1	286.040.24M
700*	30	2/10/60	46	4,4	3,2	15°	5° ATB	1	286.046.28M

* INDUSTRIAL LINE

SHOP TIPS: Use our reduction ring from 30 to 25mm order n. 299.225.00 (for saw blades Ø250-300-315)
Use our reduction ring from 30 to 25mm order n. 299.228.00 (for saw blades Ø350 and larger)

286 XTREME-DEMOLITION



INNOVATIONS
INTERNATIONAL PATENT PENDING



WOOD & NAILS



EXCLUSIVE SECURED TOOTH GEOMETRY
- BETTER HANDLES IMPACT WITH NAILS
- CUTS MORE NAILS THAN COMPETITORS

Engineered to ensure the longest tool life under the most demanding conditions. Tips are brazed deep inside the blade plate for superior nail impact resistance.



LOW MASS PLATE DESIGN

Patented design that reduces blade mass minimizes heat and substantially increases cutting efficiency with cordless and corded saws. More cuts. Less battery.

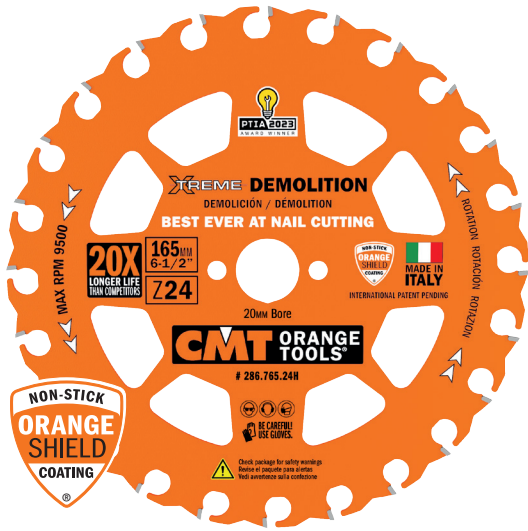

BEST EVER AT NAIL CUTTING

MACHINES



CORDLESS CIRCULAR SAW



CIRCULAR SAW

Blade diameter compatibility is contingent on machine type.

MATERIALS



DEMOLITION



WOOD/WOOD & NAILS



PRESSURE TREATED



LAMINATED BEAMS



PLYWOOD

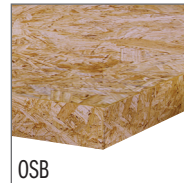

OSB



2023 PRO TOOL INNOVATION AWARDS
CIRCULAR SAW BLADE WINNER
"RECOGNITION FOR EXCELLENT VALUE,
ADVANCED FEATURES AND INNOVATION"
www.protoolinnovationawards.com



Watch the video on
YouTube



D mm	B mm	PIN HOLE	Z	K mm	P mm	α	β		ORDER NO.
160	20	2/6/32	24	2,3	1,2	5°	5° ATB	1	286.760.24H ●
165	20	2/6/32	24	2,3	1,2	5°	5° ATB	1	286.765.24H
190	30	2/7/42	24	2,3	1,2	5°	5° ATB	1	286.790.24M

● Ideal for **FESTOOL**® & others

Multi-Materials Carbide Wheel for Angle Grinder

new

CMT ORANGE TOOLS

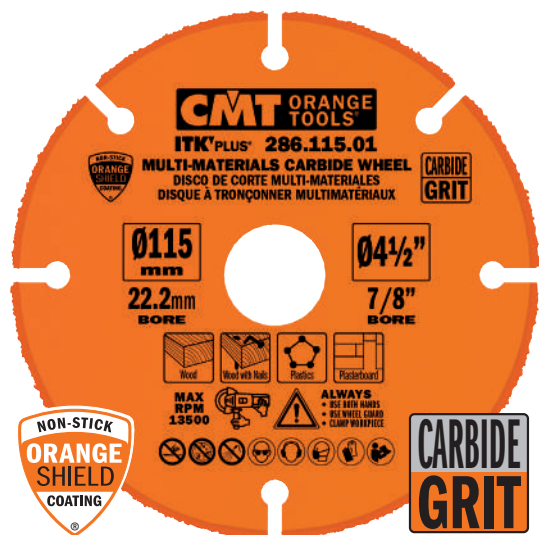

286 ITK PLUS®



MULTI-MATERIALS

D mm	B mm		ORDER NO.
115	22,2 (+9,5+15,87)	10	286.115.01
125	22,2 (+20+15,87)	10	286.125.01
230	22,2	5	286.230.01

MACHINES



Blade diameter compatibility is contingent on machine type.

MATERIALS

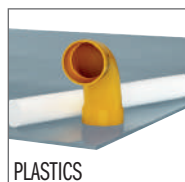

Multi-Materials Diamond Dry Wheel for Angle Grinder

new



286.61 ITK PLUS®



MULTI-MATERIALS

D mm	B mm		ORDER NO.
115	22,2 (+9,5+15,87)	10	286.115.61
125	22,2 (+20+15,87)	10	286.125.61

MACHINES



Blade diameter compatibility is contingent on machine type.

MATERIALS



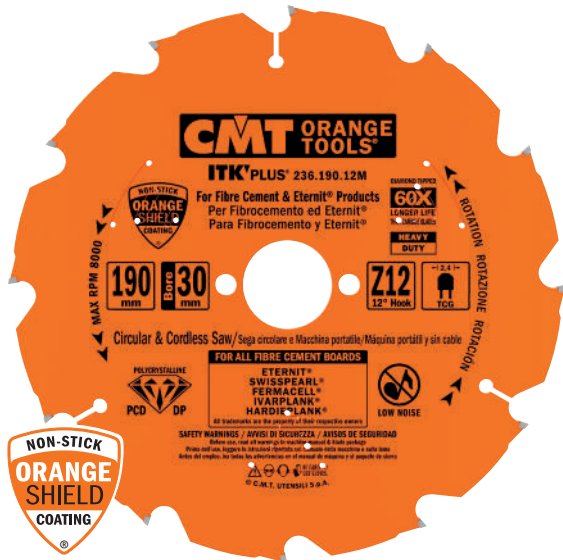

236 ITK PLUS®

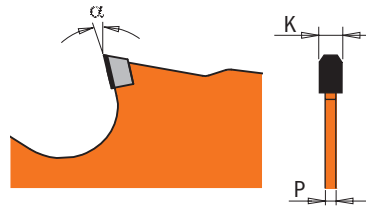

60X
LONGER LIFE
THAN CARBIDE

PCD DP LONG LIFE

★ ★ ★ ★ ★
PERFORMANCE

MULTI-MATERIALS

MACHINES

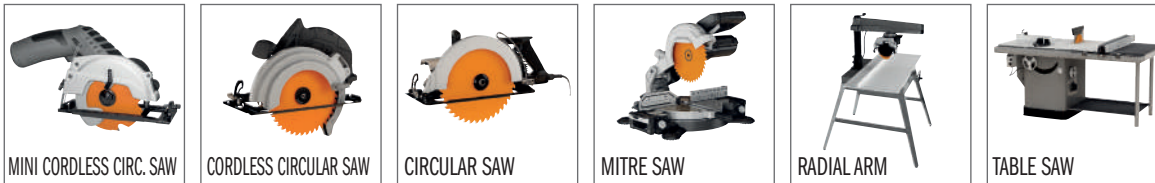

Blade diameter compatibility is contingent on machine type.

MATERIALS



IDEAL FOR:
SWISSPEARL®, FERMACELL®,
IVARPLANK®,
HARDIEPLANK®,
HARDIEPANEL®,
CORIAN®, DUROPLAST®,
FORMICA®

D mm	B mm	PIN HOLE	Z	K mm	P mm	α	β		ORDER NO.
85 *	15	-	6	1,8	1,4	12°	TCG	10	236.085.06G
125 *	22,2	-	7	2,0	1,4	5°	TCG	10	236.125.07
160	20	2/6/32	4	2,4	1,8	12°	TCG	10	236.160.04H
160	20	2/6/32	10	2,4	1,8	5°	TCG	10	236.160.10H
165	20 (+15,87)	2/6/32	4	1,8	1,4	12°	TCG	10	236.165.04H
165	20 (+15,87)	2/6/32	10	1,8	1,4	5°	TCG	10	236.165.10H
168	20	2/6/32	10	1,8	1,2	5°	TCG	10	236.168.10H ●
180	20	2/6/32	4	2,4	1,8	12°	TCG	10	236.180.04H
190	30	2/7/42	4	2,4	1,8	12°	TCG	10	236.190.04M
190	30	2/7/42	12	2,4	1,8	12°	TCG	10	236.190.12M
210	30	2/7/42	12	2,4	1,8	12°	TCG	10	236.210.12M
216	30	2/7/42	14	2,4	1,8	12°	TCG	10	236.216.14M
230	30	2/7/42	4	2,4	1,8	12°	TCG	10	236.230.04M
250	30	COMBI3	16	2,4	1,8	12°	TCG	10	236.250.16M
300	30	COMBI3	20	2,4	1,8	12°	TCG	5	236.300.20M

*Non-Silent Blades

● Ideal for **FESTOOL®** & others



K CONTRACTOR®



Designed for construction, remodeling and DIY projects. These blades deliver performance at a very economical price.



WOOD

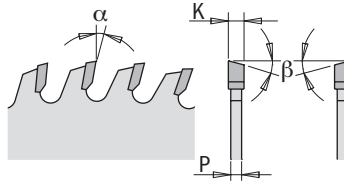

MACHINES



Blade diameter compatibility is contingent on machine type.

APPLICATIONS

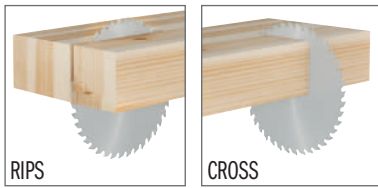

For specific details regarding applications, please check blade label.

MATERIALS



CLAMSHELL



BULK PACK 10 PCS.

DESCRIPTION	D mm	B mm	PIN HOLE	Z	K mm	P mm	α	β	CLAMSHELL	ORDER NO. CLAMSHELL	BULK PACK 10 PCS.	ORDER NO.
Finish	86	15	2/6/60	24	1,5	1,0	12°	5° ATB	10	K02403		
General Purpose	136	20	-	18	1,5	1,0	15°	15° ATB			30	K13618H-X10
General Purpose	160	20	2/6/32	24	2,2	1,4	15°	15° ATB	10	K16024H	30	K16024H-X10
Finish	160	20	2/6/32	40	2,2	1,4	15°	15° ATB	10	K16040H	30	K16040H-X10
General Purpose	165	20	2/6/32	24	1,7	1,1	15°	15° ATB	10	K16524H	30	K16524H-X10
Finish	165	20	2/6/32	40	1,7	1,1	15°	15° ATB	10			K16540H-X10
General Purpose	190	30	2/7/42	24	2,2	1,4	20°	10° ATB	10	K19024M	30	K19024M-X10
Ripping	216	30	2/7/42	24	2,4	1,6	-5° Neg.	15° ATB	10	K21624M	30	K21624M-X10
Finish	216	30	2/7/42	48	2,4	1,6	-5° Neg.	15° ATB	10	K21648M	30	K21648M-X10
General Purpose	250	30	COMBI3	40	2,6	1,8	15°	10° ATB	10	K25040M	20	K25040M-X05*

* BULK PACK 5 PCS.



K CONTRACTOR®



WOOD

CLAMSHELL COMBO PACK

3 pcs. CLAMSHELL COMBO PACK

Ø160mm Bore 20mm

DESCRIPTION	SET CONTAINS	D mm	B mm	PIN HOLE	Z	K mm	P mm	α	β		ORDER NO. CLAMSHELL
General Purpose	K16024H (1 pc.)	160	20	2/6/32	24	2,2	1,4	15°	15° ATB	10	K160H-X03
Finish	K16040H (2 pcs.)	160	20	2/6/32	40	2,2	1,4	15°	15° ATB		

3 pcs. CLAMSHELL COMBO PACK

Ø190mm Bore 30mm

DESCRIPTION	SET CONTAINS	D mm	B mm	PIN HOLE	Z	K mm	P mm	α	β		ORDER NO. CLAMSHELL
General Purpose	K19024M (2 pcs.)	190	30	2/7/42	24	2,2	1,4	20°	10° ATB	10	K190M-X03
Finish	K19040M (1 pc.)	190	30	2/7/42	40	2,2	1,4	15°	10° ATB		

3 pcs. CLAMSHELL COMBO PACK

Ø216mm Bore 30mm

DESCRIPTION	SET CONTAINS	D mm	B mm	PIN HOLE	Z	K mm	P mm	α	β		ORDER NO. CLAMSHELL
Ripping	K21624M (1 pc.)	216	30	2/7/42	24	2,4	1,6	-5° Neg.	15° ATB	10	K216M-X03
Finish	K21648M (2 pcs.)	216	30	2/7/42	48	2,4	1,6	-5° Neg.	15° ATB		

2 pcs. CLAMSHELL COMBO PACK

Ø250mm Bore 30mm

DESCRIPTION	SET CONTAINS	D mm	B mm	PIN HOLE	Z	K mm	P mm	α	β		ORDER NO. CLAMSHELL
Ripping	K25024M (1 pc.)	250	30	COMBI3	24	2,6	1,8	20°	10° ATB	10	K250M-X02
General Purpose	K25040M (1 pc.)	250	30	COMBI3	40	2,6	1,8	15°	10° ATB		

2 pcs. CLAMSHELL COMBO PACK

Ø305mm Bore 30mm

DESCRIPTION	SET CONTAINS	D mm	B mm	PIN HOLE	Z	K mm	P mm	α	β		ORDER NO. CLAMSHELL
General Purpose	K30540M (1 pc.)	305	30	COMBI3	40	2,8	2,0	-5° Neg.	10° ATB	5	K305M-X02
Finish	K30560M (1 pc.)	305	30	COMBI3	60	2,8	2,0	-5° Neg.	10° ATB		

DP - Ultra-Hard Materials - LONG LIFE



MACHINES



K CONTRACTOR®



MULTI-MATERIALS

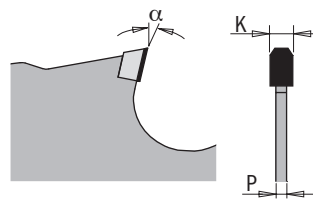

MATERIALS



IDEAL FOR:
 SWISSPEARL®, FERMACELL®, IVARPLANK®,
 HARDIEPLANK®, HARDIEPANEL®,
 CORIAN®, DUROPLAST®, FORMICA®

DESCRIPTION	D mm	B mm	PIN HOLE	Z	K mm	P mm	α	β		ORDER NO. CLAMSHELL
Multi-Materials	160	20	2/6/32	10	2,4	1,8	5°	TCG	10	K160-10HD

Multi-Rip with Rakers - THIN KERF



280 INDUSTRIAL

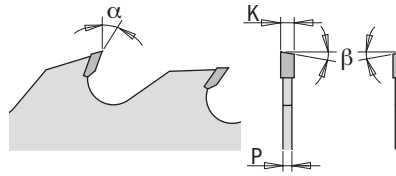

WOOD

TECHNICAL DETAILS:

The rakers prevent contact between the steel plate body and the material in use.

Thin Kerf minimises materials wastes.

MACHINES



Blade diameter compatibility is contingent on machine type.

APPLICATIONS



MATERIALS



D mm	B mm	KEY WAY 	PIN HOLE 	Z+V	K mm	P mm	T ₁ mm	α	β		ORDER NO.
180	40		-	21+3	2,5	1,8	30	18°	FLAT	1	280.021.07S
200	40		-	21+3	2,5	1,8	35	18°	FLAT	1	280.021.08S
250	70	21 x 5	-	20+4	2,7	1,8	50	18°	10° ATB	1	280.020.10V
250	80	13 x 5	-	20+4	2,7	1,8	50	18°	10° ATB	1	280.020.10W
300	70	21 x 5	-	24+4	2,7	1,8	60	18°	10° ATB	1	280.024.12V
300	80	13 x 5	-	24+4	2,7	1,8	60	18°	10° ATB	1	280.024.12W

Multi-Rip with Rakers - THICK KERF



277 INDUSTRIAL

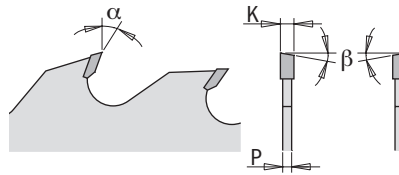

PERFORMANCE

WOOD

TECHNICAL DETAILS:

The rakers prevent contact between the steel plate body and the material in use.

Mounted on the sides of gang rip saws, these act as shoulder saw blades and ensure stability, reducing vibration under extreme work load.

MACHINES



APPLICATIONS

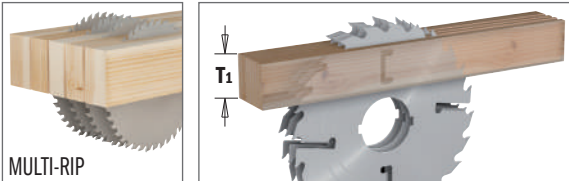

MATERIALS



D mm	B mm	KEY WAY 	PIN HOLE 	Z+V	K mm	P mm	T ₁ mm	α	β		ORDER NO.
300	30		COMBI3	24+4	4,0	2,8	80	18°	10° ATB	1	277.024.12M
300	70	21 x 5	-	24+4	4,0	2,8	80	18°	10° ATB	1	277.024.12V
300	80	13 x 5	-	24+4	4,0	2,8	80	18°	10° ATB	1	277.024.12W
350	30		COMBI3	24+6	4,2	2,8	105	18°	10° ATB	1	277.024.14M
350	70	21 x 5	-	24+6	4,2	2,8	105	18°	10° ATB	1	277.024.14V

Multi-Rip with Rakers

279 INDUSTRIAL



WOOD

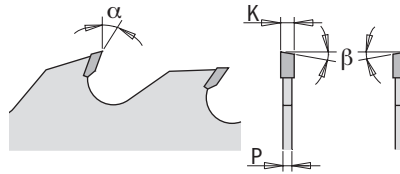

TECHNICAL DETAILS:

The rakers prevent contact between the steel plate body and the material in use.

MACHINES



Blade diameter compatibility is contingent on machine type.

APPLICATIONS

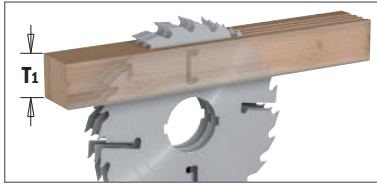

MATERIALS



D mm	B mm	KEY WAY 	PIN HOLE 	Z+V	K mm	P mm	T ₁ mm	α	β		ORDER NO.
250	30		COMBI3	20+4	3,2	2,2	65	18°	10° ATB	1	279.020.10M
250	70	21 x 5	-	20+4	3,2	2,2	65	18°	10° ATB	1	279.020.10V
250	80	13 x 5	-	20+4	3,2	2,2	65	18°	10° ATB	1	279.020.10W
300	30		COMBI3	24+4	3,2	2,2	80	18°	10° ATB	1	279.024.12M
300	60	21 x 5	-	24+4	3,2	2,2	80	18°	10° ATB	1	279.024.12U
300	70	21 x 5	-	24+4	3,2	2,2	80	18°	10° ATB	1	279.024.12V
300	80	13 x 5	-	24+4	3,2	2,2	80	18°	10° ATB	1	279.024.12W
350	30		COMBI3	28+4	3,5	2,5	105	18°	10° ATB	1	279.028.14M
350	60	21 x 5	-	28+4	3,5	2,5	105	18°	10° ATB	1	279.028.14U
350	70	21 x 5	-	28+4	3,5	2,5	105	18°	10° ATB	1	279.028.14V
350	80	14 x 5	-	28+4	3,5	2,5	105	18°	10° ATB	1	279.028.14W
400	30		COMBI3	28+6	4,0	2,8	120	18°	10° ATB	1	279.028.16M
400	70	21 x 5	-	28+6	4,0	2,8	120	18°	10° ATB	1	279.028.16V

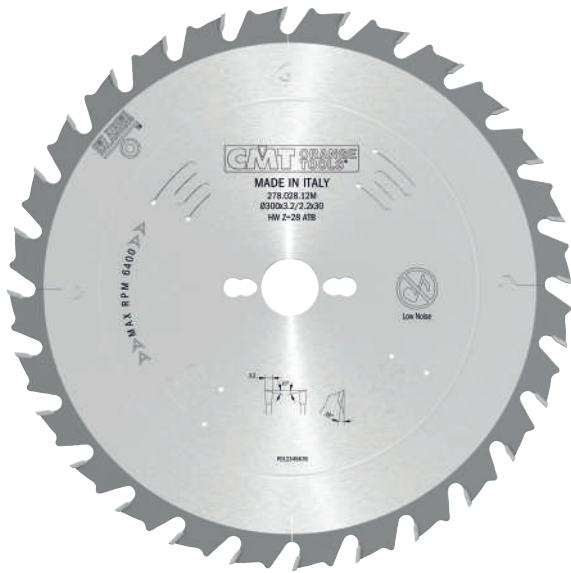

278 XTREME

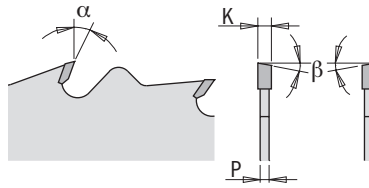

PERFORMANCE

WOOD



MACHINES



SQUARING



MULTI-RIP

Blade diameter compatibility is contingent on machine type.

APPLICATIONS



MULTI-RIP



RIPS



MATERIALS



HARDWOOD



SOFTWOOD

D mm	B mm	KEY WAY 	PIN HOLE 	Z	K mm	P mm	α	β		ORDER NO.
300	30		COMBI3	28	3,2	2,2	18°	10° ATB	1	278.028.12M
300	70	21 x 5	-	28	3,2	2,2	18°	10° ATB	1	278.028.12V
350	30		COMBI3	36	3,5	2,5	18°	10° ATB	1	278.036.14M
350	70	21 x 5	-	36	3,5	2,5	18°	10° ATB	1	278.036.14V

Ripping



WOOD



285 ORANGE CHROME®

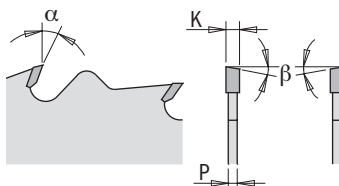

MACHINES



Blade diameter compatibility is contingent on machine type.

APPLICATIONS



MATERIALS



D mm	B mm	PIN HOLE 	Z	K mm	P mm	α	β		ORDER NO.
250	30	COMBI3	24	3,2	2,2	10°	FLAT	1	285.624.10M

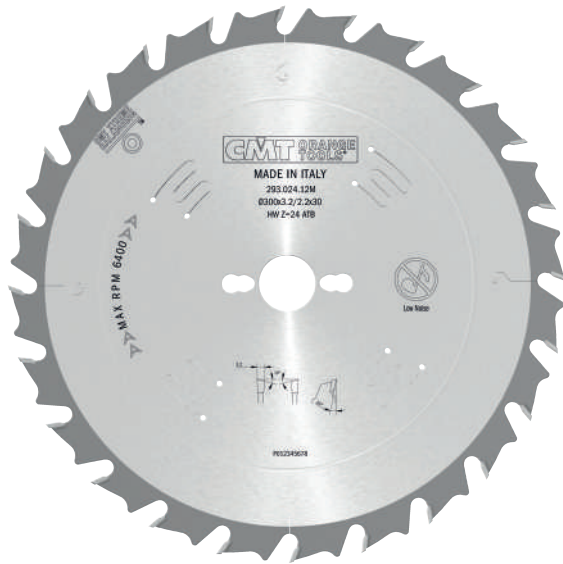

285-293 XTREME

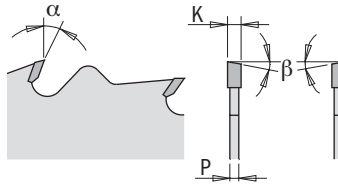

WOOD



MACHINES



Blade diameter compatibility is contingent on machine type.

APPLICATIONS



MATERIALS



D mm	B mm	PIN HOLE ⊕⊖⊕	Z	K mm	P mm	α	β		ORDER NO.
300	30	COMBI3	24	3,2	2,2	20°	10° ATB	1	293.024.12M
300	35	-	24	3,2	2,2	20°	10° ATB	1	293.024.12R
305	30	2/10/60	28	2,8	1,8	20°	10° ATB	1	293.028.22M
315	30	COMBI3	28	3,2	2,2	20°	10° ATB	1	293.028.12M
315	30	COMBI3	36	3,2	2,2	15°	5° ATB	1	285.036.13M
350	30	COMBI3	28	3,5	2,5	20°	10° ATB	1	293.028.14M
350	35	-	28	3,5	2,5	20°	10° ATB	1	293.028.14R
400	30	COMBI3	36	3,5	2,5	20°	10° ATB	1	285.036.16M
450	30	COMBI3	36	3,8	2,8	20°	10° ATB	1	285.036.18M
500	30	COMBI3	44	4,0	2,8	20°	10° ATB	1	285.044.20M



290 INDUSTRIAL

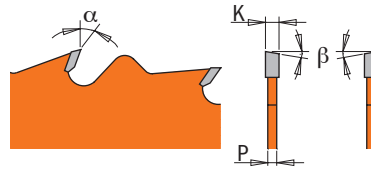

WOOD

MACHINES

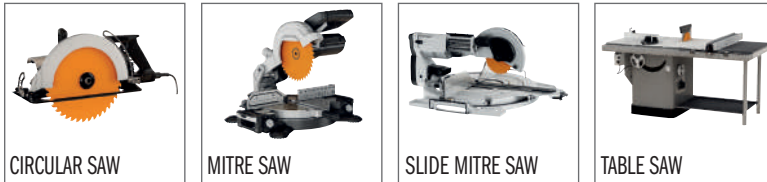

Blade diameter compatibility is contingent on machine type.

APPLICATIONS



MATERIALS



D mm	B mm	PIN HOLE ⊕⊕	Z	K mm	P mm	α	β		ORDER NO.
150	20	-	12	2,4	1,4	20°	10° ATB	10	290.150.12H
160	16	-	12	2,2	1,6	20°	10° ATB	5	290.160.12E ■
160	20 (+16)	2/6/32	12	2,2	1,6	20°	10° ATB	10	290.160.12H ●
180	30	2/7/42	12	2,6	1,6	20°	10° ATB	10	290.180.12M
190	20	2/6/32	12	2,6	1,6	20°	10° ATB	5	290.190.12H ■
190	30 (+20+16)	2/7/42	12	2,6	1,6	20°	10° ATB	10	290.190.12M
200	30	2/7/42	24	2,8	1,8	20°	10° ATB	10	290.200.24M
210	30	2/7/42	24	2,8	1,8	20°	10° ATB	10	290.210.24M ●
216	30	2/7/42	24	2,8	1,8	-5° Neg.	15° ATB	10	290.216.24M ●
220	30	2/7/42	24	2,8	1,8	20°	10° ATB	10	290.220.24M
230	30	2/7/42	24	2,8	1,8	20°	10° ATB	10	290.230.24M ●
235	25	-	24	2,8	1,8	20°	10° ATB	5	290.235.24L ■
235	30 (+25)	2/7/42	24	2,8	1,8	20°	10° ATB	10	290.235.24M
240	30	2/7/42	24	2,8	1,8	20°	10° ATB	10	290.240.24M
250	30	COMBI3	24	2,8	1,8	20°	10° ATB	5	290.250.24M
260	30	COMBI3	28	2,8	1,8	20°	10° ATB	5	290.260.28M ●
270	30	COMBI3	28	2,8	1,8	20°	10° ATB	5	290.270.28M

● Ideal for **FESTOOL®** & others

■ Until stock last

271 ITK^{PLUS}



WOOD

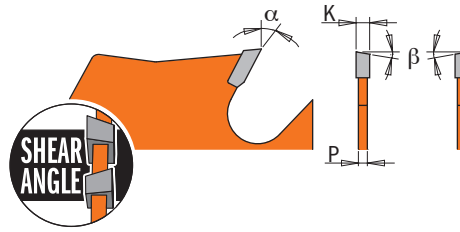

MACHINES



Blade diameter compatibility is contingent on machine type.

APPLICATIONS



MATERIALS



For specific details regarding suggested materials, please check blade label.

D mm	B mm	PIN HOLE	Z	K mm	P mm	α	β		ORDER NO.
250	30	COMBI3	24	2,4	1,6	20°	10° ATB + 8° Shear	10	271.250.24M
300	30	COMBI3	24	2,6	1,8	22°	10° ATB + 8° Shear	5	271.300.24M

Ripping & Crosscut [General Purpose]



285.6 ORANGE CHROME®



WOOD

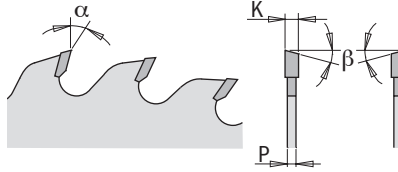

MACHINES



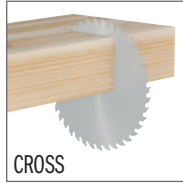

Blade diameter compatibility is contingent on machine type.

APPLICATIONS



MATERIALS



D mm	B mm	PIN HOLE 	Z	K mm	P mm	α	β		ORDER NO.
250	30	COMBI3	40	3,2	2,2	5°	10° ATB	1	285.640.10M
300	30	COMBI3	48	3,2	2,2	5°	10° ATB	1	285.648.12M
350	30	COMBI3	54	3,5	2,5	5°	10° ATB	1	285.654.14M
400	30	COMBI3	60	3,5	2,5	10°	15° ATB	1	285.660.16M

Ripping & Crosscut [General Purpose]

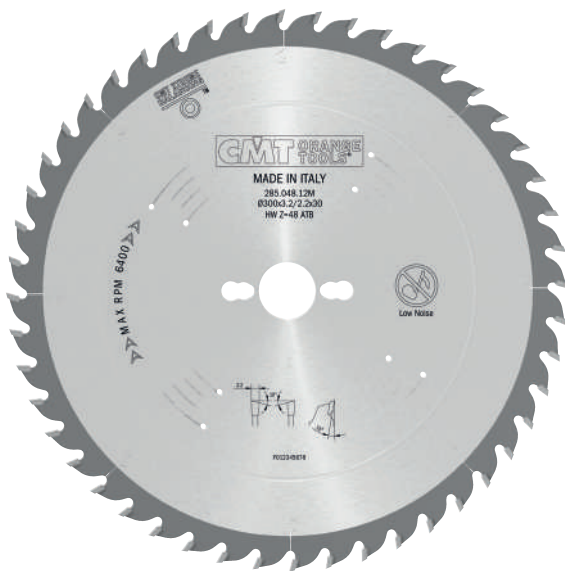

285-294 XTREME

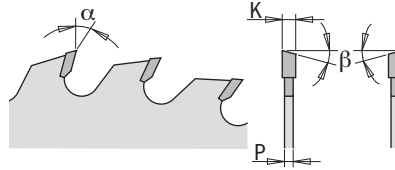

WOOD



MACHINES



APPLICATIONS



Blade diameter compatibility is contingent on machine type.

MATERIALS



For specific details regarding suggested materials, please check blade label.

D mm	B mm	PIN HOLE 	Z	K mm	P mm	α	β		ORDER NO.
250*	20	-	40	3,2	2,2	15°	10° ATB	1	285.040.10H
250	30	COMBI3	40	3,2	2,2	5°	10° ATB	1	285.040.10M
250	35	-	40	3,2	2,2	15°	10° ATB	1	285.040.10R
250	30	COMBI3	48	3,2	2,2	15°	10° ATB	1	285.048.10M
254	30	COMBI3	48	2,4	1,8	-5° Neg.	15° ATB	1	294.048.10M
275	20	-	42	3,2	2,2	15°	10° ATB	1	285.042.11H
300	30	COMBI3	36	3,2	2,2	15°	10° ATB	1	285.036.12M
300*	20	COMBI3	48	3,2	2,2	15°	10° ATB	1	285.048.12H
300	30	COMBI3	48	3,2	2,2	5°	10° ATB	1	285.048.12M
300	35	-	48	3,2	2,2	15°	10° ATB	1	285.048.12R
305	30	2/10/60 + 2/7/42	54	2,8	1,8	-5° Neg.	15° ATB	1	294.054.22M
315*	30	COMBI3	54	3,2	2,2	15°	10° ATB	1	294.054.12M
350	30	COMBI3	54	3,5	2,5	5°	10° ATB	1	285.054.14M
350	35	-	54	3,5	2,5	15°	10° ATB	1	285.054.14R
400	30	COMBI3	48	3,5	2,5	20°	10° ATB	1	285.048.16M
400	30	COMBI3	60	3,5	2,5	10°	15° ATB	1	285.060.16M
450	30	COMBI3	54	3,8	2,8	15°	15° ATB	1	285.054.18M
500	30	COMBI3	60	3,8	2,8	15°	15° ATB	1	285.060.20M
550	30	2/10/60	60	4,2	3,2	10°	15° ATB	1	285.060.22M
600	30	2/10/60	66	4,2	3,2	10°	15° ATB	1	285.066.24M
700*	30	2/10/60	72	4,4	3,2	10°	15° ATB	1	285.072.28M

* INDUSTRIAL LINE

* Non-Silent Blades

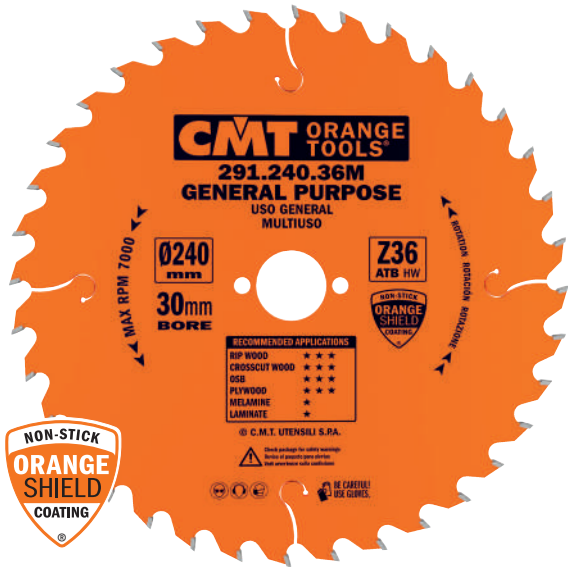

285-291 INDUSTRIAL



WOOD

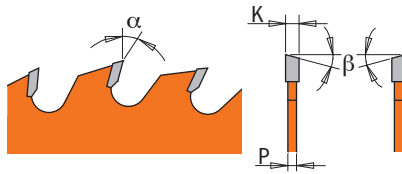

MACHINES



Blade diameter compatibility is contingent on machine type.

APPLICATIONS



MATERIALS

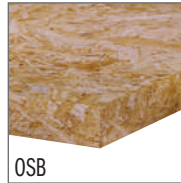

D mm	B mm	PIN HOLE	Z	K mm	P mm	α	β	APPLICATIONS	📦	ORDER NO.
120	20	2/5,5/30	18	1,8	1,2	15°	15° ATB	General Purpose	10	291.120.18H
125	20	-	20	2,4	1,4	15°	15° ATB	General Purpose	10	291.125.20H
130	20	-	20	2,4	1,4	15°	15° ATB	General Purpose	10	291.130.20H
140	20	-	20	2,4	1,4	15°	15° ATB	General Purpose	10	291.140.20H
150	20 (+16)	-	24	2,4	1,4	15°	15° ATB	General Purpose	10	291.150.24H
160	20	2/6/32	24	2,2	1,6	15°	15° ATB	General Purpose	10	291.160.24H ●
160	20	2/6/32	28	2,2	1,6	15°	10° ATB	General Purpose	10	285.160.28H ⚠️
160	30 (+16)	2/7/42	24	2,2	1,6	15°	15° ATB	General Purpose	10	291.160.24M
165	20	2/6/32	24	2,2	1,6	15°	15° ATB	General Purpose	10	291.165.24H
165	30	2/7/42	24	2,6	1,6	15°	15° ATB	General Purpose	10	291.165.24M
170	30	2/7/42	24	2,6	1,6	20°	10° ATB	General Purpose	10	291.170.24M
180	20	2/6/32	24	2,6	1,6	20°	10° ATB	General Purpose	10	291.180.24H
180	30	2/7/42	24	2,6	1,6	20°	10° ATB	General Purpose	10	291.180.24M
184	16	-	24	2,6	1,6	20°	10° ATB	General Purpose	10	291.184.24E
184	30	-	24	2,6	1,6	20°	10° ATB	General Purpose	10	291.184.24M
190	16	2/6/32	24	2,6	1,6	20°	10° ATB	General Purpose	10	291.190.24E
190	20	2/6/32	24	2,6	1,6	20°	10° ATB	General Purpose	10	291.190.24H
190	30	2/7/42	24	2,6	1,6	20°	10° ATB	General Purpose	10	291.190.24M
190	20 (FESTOOL® FF)	Key 5/7/2,5	32	2,6	1,8	10°	10° ATB	General Purpose	10	291.190.32FF ●
200	30	2/7/42	36	2,8	1,8	15°	15° ATB	General Purpose	10	291.200.36M
200	30	COMBI3	36	3,2	2,2	15°	10° ATB	General Purpose	10	285.036.08M ⚠️
210	25	-	36	2,8	1,8	15°	15° ATB	General Purpose	5	291.210.36L ■
210	30	2/7/42	36	2,8	1,8	15°	15° ATB	General Purpose	10	291.210.36M ●
216	30	2/7/42	48	2,8	1,8	-5° Neg.	15° ATB	Finish	10	291.216.48M ●
220	30	2/7/42	36	2,8	1,8	15°	15° ATB	General Purpose	10	291.220.36M
225	30	2/7/42	36	2,8	1,8	20°	15° ATB	General Purpose	10	291.225.36M ●
230	30	2/7/42	36	2,8	1,8	15°	15° ATB	General Purpose	10	291.230.36M ●
235	25	-	36	2,8	1,8	15°	15° ATB	General Purpose	5	291.235.36L ■
235	30	2/7/42	36	2,8	1,8	15°	15° ATB	General Purpose	10	291.235.36M
240	30	2/7/42	36	2,8	1,8	15°	15° ATB	General Purpose	10	291.240.36M
260	30	COMBI3	48	2,8	1,8	15°	10° ATB	General Purpose	5	285.048.11M ●
270	30	COMBI3	42	2,8	1,8	15°	10° ATB	General Purpose	5	291.270.42M

● Ideal for FESTOOL® & others

■ Until stock last

Ripping & Crosscut [General Purpose] - THIN KERF

271 ITK^{PLUS}



WOOD

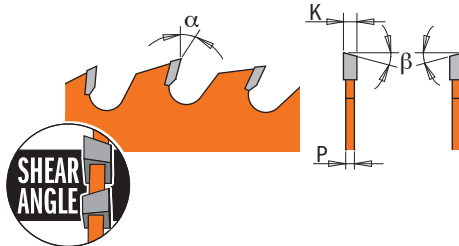
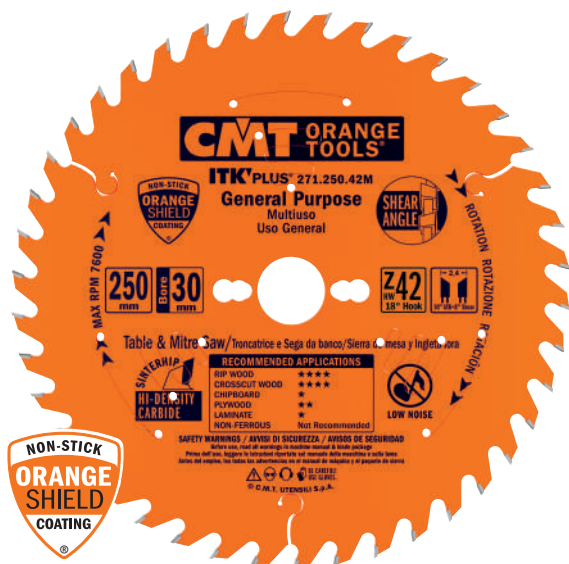

MACHINES

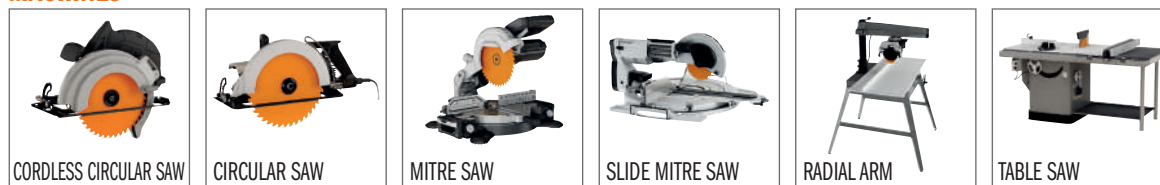

Blade diameter compatibility is contingent on machine type.

APPLICATIONS

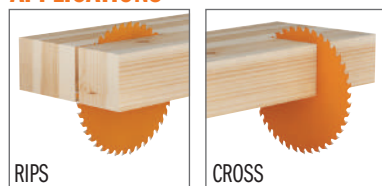

MATERIALS



D mm	B mm	PIN HOLE	Z	K mm	P mm	α	β		ORDER NO.
136	20 (+10)	-	18	1,5	1,0	20°	10° ATB + 8° Shear	10	271.136.18H
140	20	2/6/32,5	24	1,8	1,2	15°	15° ATB + 8° Shear	10	271.140.24H
150	20 (+16)	-	24	1,5	1,0	18°	10° ATB + 8° Shear	10	271.150.24H
160	20 (+16)	2/6/32	24	1,8	1,2	18°	10° ATB + 8° Shear	10	271.160.24H
165	20 (+15,87)	2/6/32	24	1,7	1,1	18°	10° ATB + 8° Shear	10	271.165.24H
165	30	2/7/42	24	1,7	1,1	18°	10° ATB + 8° Shear	10	271.165.24M
168	20	2/6/32	28	1,8	1,2	15°	15° ATB + 8° Shear	10	271.168.28H ●
184	20 (+16+15,87)	2/7/42	24	1,7	1,1	20°	10° ATB + 8° Shear	10	271.184.24H
184	30	2/7/42	24	1,7	1,1	20°	10° ATB + 8° Shear	10	271.184.24M
190	30 (+20+16)	2/7/42	24	1,7	1,1	20°	10° ATB + 8° Shear	10	271.190.24M
200	30	2/7/42	36	1,8	1,2	15°	10° ATB + 8° Shear	10	271.200.36M
210	30 (+25)	2/7/42	24	1,8	1,2	20°	10° ATB + 8° Shear	10	271.210.24M
210	30 (+25)	2/7/42	36	1,8	1,2	15°	10° ATB + 8° Shear	10	271.210.36M
216	30	2/7/42	36	1,8	1,2	-5° Neg.	10° ATB + 8° Shear	10	271.216.36M ■
235	25	-	36	1,7	1,2	20°	1 FLAT+2/15° ATB	10	271.235.36L
235	30 (+25)	2/7/42	36	2,4	1,6	18°	10° ATB + 8° Shear	10	271.235.36M
250	30	COMBI3	42	2,4	1,6	18°	10° ATB + 8° Shear	10	271.250.42M
300	30	COMBI3	48	2,6	1,8	18°	10° ATB + 8° Shear	5	271.300.48M
305	30	COMBI3	48	2,6	1,8	-5° Neg.	10° ATB	5	271.305.48M
315	30	COMBI3	54	2,6	1,8	-5° Neg.	10° ATB	5	271.315.54M

● Ideal for FESTOOL® & others

■ Until stock last

© Brand names mentioned in CMT products are the property of their respective owners (see back cover)



285 ORANGE CHROME®



WOOD

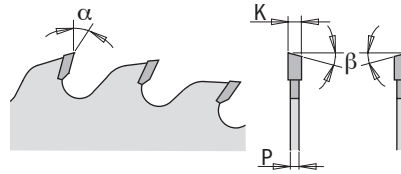

MACHINES

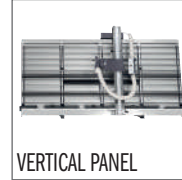

Blade diameter compatibility is contingent on machine type.



APPLICATIONS

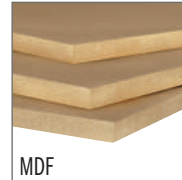

MATERIALS



For specific details regarding suggested materials, please check blade label.

D mm	B mm	PIN HOLE 	Z	K mm	P mm	α	β		ORDER NO.
216	30	2/7/42	48	2,3	1,6	-5° Neg.	15° ATB	1	285.816.48M ●
250	30	COMBI3	60	3,2	2,2	10°	15° ATB	1	285.660.10M
260	30	COMBI3	60	2,5	1,8	-5° Neg.	10° ATB	1	285.860.11M ●
300	30	COMBI3	72	3,2	2,2	10°	15° ATB	1	285.672.12M
350	30	COMBI3	84	3,5	2,5	10°	15° ATB	1	285.684.14M
400	30	COMBI3	96	3,5	2,5	10°	15° ATB	1	285.696.16M

● Ideal for **FESTOOL®** & others



285-294-295 XTREME

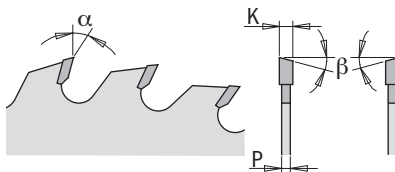

PERFORMANCE

WOOD



MACHINES



Blade diameter compatibility is contingent on machine type.



APPLICATIONS



MATERIALS



For specific details regarding suggested materials, please check blade label.

D mm	B mm	PIN HOLE 	Z	K mm	P mm	α	β		ORDER NO.
250	30	COMBI3	60	3,2	2,2	10°	15° ATB	1	285.060.10M
250	35	-	60	3,2	2,2	10°	15° ATB	1	285.060.10R
254	30	COMBI3	60	2,4	1,8	-5° Neg.	15° ATB	1	294.060.10M
280*	30	COMBI3	64	2,8	1,8	10°	15° ATB	1	295.064.11M
300	30	COMBI3	60	3,2	2,2	15°	10° ATB	1	285.060.12M
300	30	COMBI3	72	3,2	2,2	10°	15° ATB	1	285.072.12M
300	35	-	72	3,2	2,2	10°	15° ATB	1	285.072.12R
305	30	COMBI3	72	3,2	2,2	10°	15° ATB	1	285.072.22M
305	30	COMBI3	72	3,2	2,2	-5° Neg.	15° ATB	1	294.072.22M
315	30	COMBI3	72	3,2	2,2	15°	10° ATB	1	285.072.13M
350	30	COMBI3	72	3,5	2,5	15°	10° ATB	1	285.072.14M
350	30	COMBI3	84	3,5	2,5	10°	15° ATB	1	285.084.14M
350	35	-	84	3,5	2,5	10°	15° ATB	1	285.084.14R
400	30	COMBI3	96	3,5	2,5	10°	15° ATB	1	285.096.16M
450	30	COMBI3	66	3,8	2,8	10°	15° ATB	1	285.066.18M
500	30	2/10/60	72	3,8	2,8	10°	15° ATB	1	285.072.20M
550	30	2/10/60	96	4,2	3,2	10°	15° ATB	1	285.096.22M

*Non-Silent Blades



285-292-294 INDUSTRIAL



WOOD

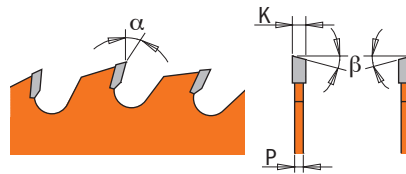

MACHINES



CIRCULAR SAW



MITRE SAW



SLIDE MITRE SAW



TABLE SAW

Blade diameter compatibility is contingent on machine type.

APPLICATIONS



CROSS

MATERIALS



WOOD



OSB



PLYWOOD



MELAMINE



LAMINATE

D mm	B mm	PIN HOLE	Z	K mm	P mm	α	β	APPLICATIONS		ORDER NO.
120	20	2/5,5/30	40	1,8	1,2	10°	15° ATB	Fine Finish	10	292.120.40H
125	20	-	36	2,4	1,4	15°	15° ATB	Fine Finish	10	292.125.36H
130	20	-	36	2,4	1,4	15°	15° ATB	Fine Finish	10	292.130.36H
140	20	-	36	2,4	1,4	15°	15° ATB	Fine Finish	10	292.140.36H
150	20	-	40	2,4	1,4	15°	15° ATB	Fine Finish	10	292.150.40H
150	30	2/7/42	48	3,2	2,2	5°	15° ATB	Fine Finish	10	285.048.06M
160	20	2/6/32	40	2,2	1,6	10°	15° ATB	Finish	10	292.160.40H ●
160	30	2/7/42	40	2,2	1,6	10°	15° ATB	Finish	10	292.160.40M
160	20	2/6/32	48	2,2	1,6	5°	15° ATB	Fine Finish	10	285.160.48H ●
165	20	2/6/32	40	2,2	1,6	10°	15° ATB	Finish	10	292.165.40H
165	30	2/7/42	40	2,6	1,6	10°	15° ATB	Finish	10	292.165.40M
170	30	2/7/42	40	2,6	1,6	15°	15° ATB	Finish	10	292.170.40M
180	20	2/6/32	40	2,6	1,6	15°	15° ATB	Finish	10	292.180.40H
180	30	2/7/42	40	2,6	1,6	15°	15° ATB	Finish	10	292.180.40M
180	30	2/7/42	56	3,2	2,2	5°	15° ATB	Fine Finish	10	285.056.07M
184	16	-	40	2,6	1,6	15°	15° ATB	Finish	10	292.184.40E
184	30	-	40	2,6	1,6	15°	15° ATB	Finish	10	292.184.40M
190	20 (+16)	2/6/32	40	2,6	1,6	15°	15° ATB	Finish	10	292.190.40H
190	30	2/7/42	40	2,6	1,6	15°	15° ATB	Finish	10	292.190.40M
190	20 (FESTOOL® FF)	Key 5/7/2,5	48	2,4	1,8	10°	15° ATB	Fine Finish	10	292.190.48FF ●
200	30	2/7/42	48	2,8	1,8	15°	15° ATB	Finish	10	292.200.48M
200	30	COMBI3	48	3,2	2,2	15°	15° ATB	Finish	10	285.048.08M
210	25	-	48	2,8	1,8	15°	15° ATB	Finish	5	292.210.48L ■
210	30	2/7/42	48	2,8	1,8	15°	15° ATB	Finish	10	292.210.48M ●
216	30	2/7/42	64	2,8	1,8	-5° Neg.	15° ATB	Fine Finish	10	292.216.64M ●
220	30	2/7/42	48	2,8	1,8	15°	15° ATB	Finish	10	292.220.48M
225	30	2/7/42	48	2,8	1,8	10°	15° ATB	Finish	10	292.225.48M ●
230	30	2/7/42	48	2,8	1,8	15°	15° ATB	Finish	10	292.230.48M ●
235	25	-	48	2,8	1,8	15°	15° ATB	Finish	5	292.235.48L ■
235	30	2/7/42	48	2,8	1,8	15°	15° ATB	Finish	10	292.235.48M
240	30	2/7/42	48	2,8	1,8	15°	15° ATB	Finish	10	292.240.48M
260	30	COMBI3	60	2,8	1,8	10°	15° ATB	Finish	5	285.060.11M ●
260	30	COMBI3	60	2,5	1,8	-5° Neg.	15° ATB	Finish	5	294.060.11M ●

● Ideal for FESTOOL® & others

■ Until stock last



272 ITK⁺ PLUS®



WOOD

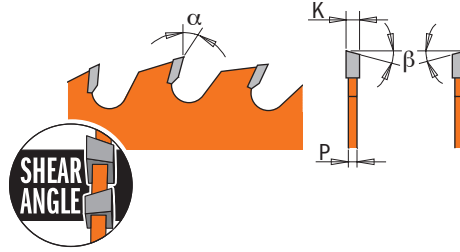

MACHINES



MINI CORDLESS CIRC. SAW



CORDLESS CIRCULAR SAW



CIRCULAR SAW



MITRE SAW



SLIDE MITRE SAW



RADIAL ARM



TABLE SAW

Blade diameter compatibility is contingent on machine type.

APPLICATIONS



CROSS

MATERIALS



WOOD

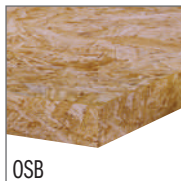

OSB



PLYWOOD



MELAMINE



LAMINATE

D mm	B mm	PIN HOLE 	Z	K mm	P mm	α	β		ORDER NO.
115	9,5	-	24	1,5	1,0	20°	10° ATB + 8° Shear	10	272.115.24
136	20 (+10)	-	36	1,5	1,0	18°	10° ATB + 8° Shear	10	272.136.36H
140	20	2/6/32,5	42	1,8	1,2	5°	15° ATB + 8° Shear	10	272.140.42H
150	20 (+16)	-	40	1,5	1,0	16°	10° ATB + 8° Shear	10	272.150.40H
160	20 (+16)	2/6/32	40	1,8	1,2	16°	10° ATB + 8° Shear	10	272.160.40H
165	20 (+15,87)	2/6/32	36	1,7	1,1	20°	10° ATB + 8° Shear	10	272.165.36H
new 168	20	2/6/32	42	1,8	1,2	10°	15° ATB + 8° Shear	10	272.168.42H ●
184	20 (+16+15,87)	2/7/42	40	1,7	1,1	18°	10° ATB + 8° Shear	10	272.184.40H
184	30	2/7/42	40	1,7	1,1	18°	10° ATB + 8° Shear	10	272.184.40M
190	30 (+20+16)	2/7/42	42	1,7	1,1	18°	10° ATB + 8° Shear	10	272.190.42M
200	30	2/7/42	48	1,8	1,2	15°	10° ATB + 8° Shear	10	272.200.48M
210	30 (+25)	2/7/42	48	1,8	1,2	15°	10° ATB + 8° Shear	10	272.210.48M
216	30	2/7/42	48	1,8	1,2	-5° Neg.	10° ATB + 8° Shear	10	272.216.48M
235	30 (+25)	2/7/42	48	2,4	1,6	18°	10° ATB + 8° Shear	10	272.235.48M
new 250*	30	COMBI3	50	2,4	1,6	15°	FLAT + 10° ATB + 8° Shear	10	272.250.50M
250	30	COMBI3	60	2,4	1,6	15°	10° ATB + 8° Shear	10	272.250.60M
300	30	COMBI3	72	2,6	1,8	15°	10° ATB + 8° Shear	5	272.300.72M
305	30	COMBI3	72	2,6	1,8	-5° Neg.	10° ATB	5	272.305.72M

*with Antikick-back

● Ideal for **FESTOOL®** & others



285 ORANGE CHROME®



WOOD

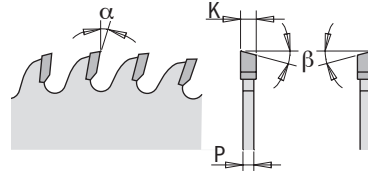

MACHINES

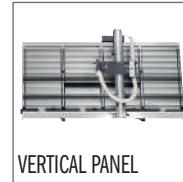

Blade diameter compatibility is contingent on machine type.

APPLICATIONS



MATERIALS

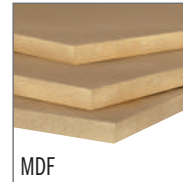

For specific details regarding suggested materials, please check blade label.

D mm	B mm	PIN HOLE	Z	K mm	P mm	α	β	Box	ORDER NO.
160	20		48	2,2	1,6	5°	12° ATB	1	285.760.48H ●
160	20		48	1,8	1,2	5°	12° ATB	1	285.761.48H ●
168	20		48	1,8	1,2	5°	12° ATB	1	285.768.48H ●
190	20 (FESTOOL® FF)	-	48	2,4	1,8	8°	15° ATB	1	285.790.48FF ●
216	30		60	2,3	1,6	-5° Neg.	15° ATB	1	285.816.60M ●
250	30	COMBI3	80	3,2	2,2	5°	15° ATB	1	285.680.10M
300	30	COMBI3	96	3,2	2,2	5°	15° ATB	1	285.696.12M
350	30	COMBI3	108	3,5	2,5	5°	15° ATB	1	285.708.14M

● Ideal for FESTOOL® & others

RESULTS OF OUR TEST

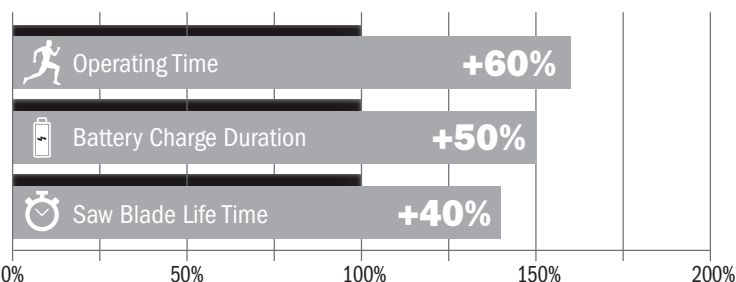

FULL KERF BLADE (K=2,2mm)

THIN KERF BLADE (K=1,8mm)

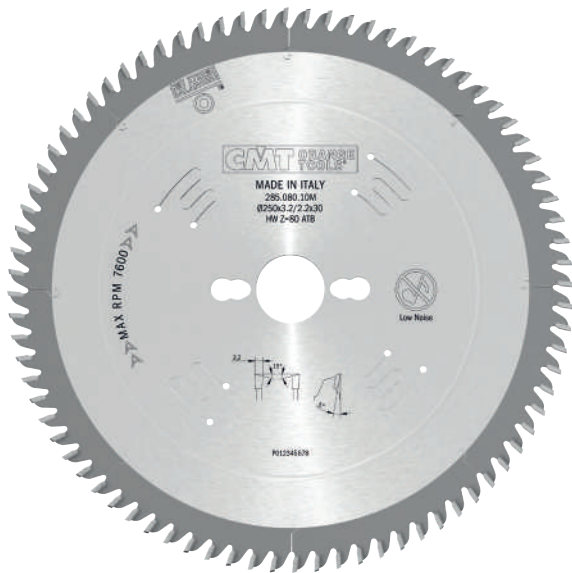

285 XTREME

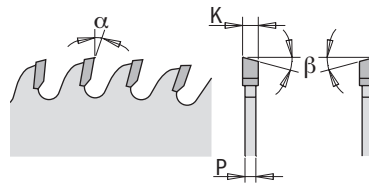

WOOD



MACHINES

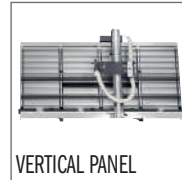

Blade diameter compatibility is contingent on machine type.

APPLICATIONS



MATERIALS

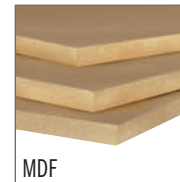

D mm	B mm	PIN HOLE ⊕⊕	Z	K mm	P mm	α	β		ORDER NO.
250	30	COMBI3	80	3,2	2,2	5°	15° ATB	1	285.080.10M
250	35	-	80	3,2	2,2	5°	15° ATB	1	285.080.10R
300	30	COMBI3	96	3,2	2,2	5°	15° ATB	1	285.096.12M
300	35	-	96	3,2	2,2	5°	15° ATB	1	285.096.12R
350	30	COMBI3	108	3,5	2,5	5°	15° ATB	1	285.108.14M
350	35	-	108	3,5	2,5	5°	15° ATB	1	285.108.14R
400	30	COMBI3	120	3,5	2,5	10°	15° ATB	1	285.120.16M



287 INDUSTRIAL

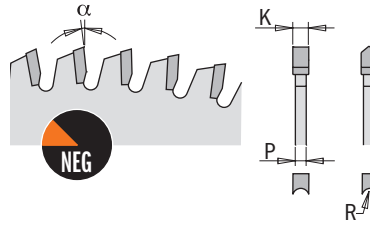

WOOD

MACHINES



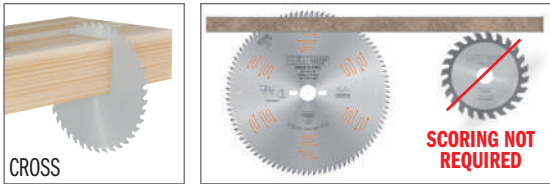

Blade diameter compatibility is contingent on machine type.

APPLICATIONS



MATERIALS



D mm	B mm	PIN HOLE 	Z	K mm	P mm	α	β		ORDER NO.
220	30	2/7/42	42	3,2	2,2	-6° Neg.	HDF	1	287.043.09M
250	30	COMBI3	48	3,2	2,2	-6° Neg.	HDF	1	287.049.10M
303	30	COMBI3	60	3,2	2,2	-6° Neg.	HDF	1	287.061.12M

287 INDUSTRIAL



WOOD

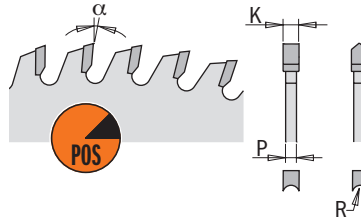

MACHINES



Blade diameter compatibility is contingent on machine type.

APPLICATIONS

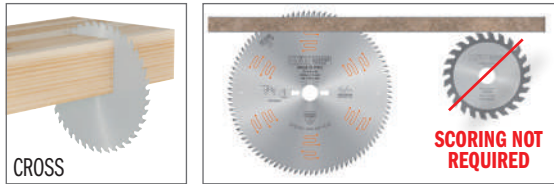

MATERIALS



D mm	B mm	PIN HOLE 	Z	K mm	P mm	α	β		ORDER NO.
160	20	2/6/32	34	2,6	1,8	10°	HDF	1	287.034.06H
220	30	2/7/42	42	3,2	2,2	10°	HDF	1	287.042.09M
250	30	COMBI3	48	3,2	2,2	10°	HDF	1	287.048.10M
303	30	COMBI3	60	3,2	2,2	10°	HDF	1	287.060.12M



285-292-294 INDUSTRIAL



WOOD

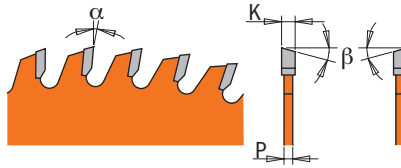

MACHINES







Blade diameter compatibility is contingent on machine type.

APPLICATIONS



MATERIALS



D mm	B mm	PIN HOLE 	Z	K mm	P mm	α	β		ORDER NO.
160	20	2/6/32	56	2,2	1,6	15°	15° ATB	10	292.160.56H ●
165	20	2/6/32	56	2,2	1,6	15°	15° ATB	10	292.165.56H ●
190	30	2/7/42	64	2,6	1,6	15°	15° ATB	10	292.190.64M ●
200	30	COMBI3	64	3,2	2,2	5°	15° ATB	10	 285.064.08M ●
210	30	2/7/42	64	2,8	1,8	15°	15° ATB	10	292.210.64M ●
216	30	2/7/42	80	2,8	1,8	-5° Neg.	15° ATB	10	292.216.80M ●
230	30	2/7/42 + 2/10/60	64	2,8	1,8	15°	15° ATB	10	292.230.64M ●
260	30	COMBI3	80	2,5	1,8	-5° Neg.	15° ATB	5	 294.080.11M ●

● Ideal for **FESTOOL**® & others



273 ITK⁺ PLUS®



WOOD

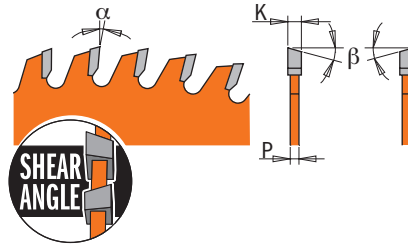

MACHINES

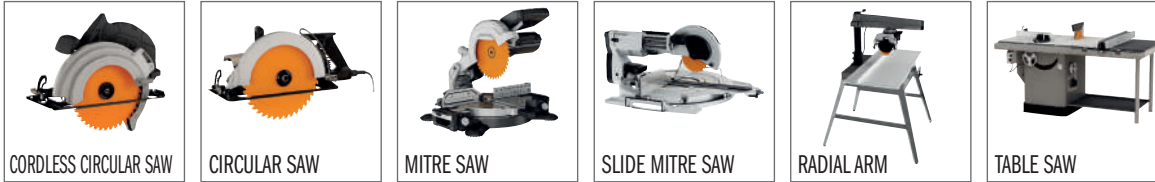

Blade diameter compatibility is contingent on machine type.

APPLICATIONS

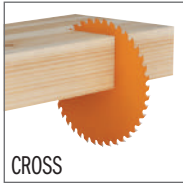

MATERIALS



For specific details regarding suggested materials, please check blade label.

D mm	B mm	PIN HOLE 	Z	K mm	P mm	α	β		ORDER NO.
50	10	-	20	1,1	0,8	15°	10° ATB	10	273.050.20D ●
80	10	-	36	1,6	1,0	15°	10° ATB	10	273.080.36D ●
160	20 (+16)	2/6/32	56	1,8	1,2	12°	10° ATB + 8° Shear	10	273.160.56H
165	20 (+15,87)	2/6/32	56	1,6	1,0	12°	15° ATB + 8° Shear	10	273.165.56H
190	30 (+20+16)	2/7/42	64	1,7	1,1	15°	10° ATB + 8° Shear	10	273.190.64M
216	30	2/7/42	64	1,8	1,2	-5° Neg.	10° ATB + 8° Shear	10	273.216.64M
250	30	COMBI3	80	2,4	1,6	12°	10° ATB + 8° Shear	10	273.250.80M
300	30	COMBI3	96	2,6	1,8	12°	10° ATB + 8° Shear	5	273.300.96M

● Ideal for PROXXON® (Materials: Wood, Plastics, Non-ferrous)

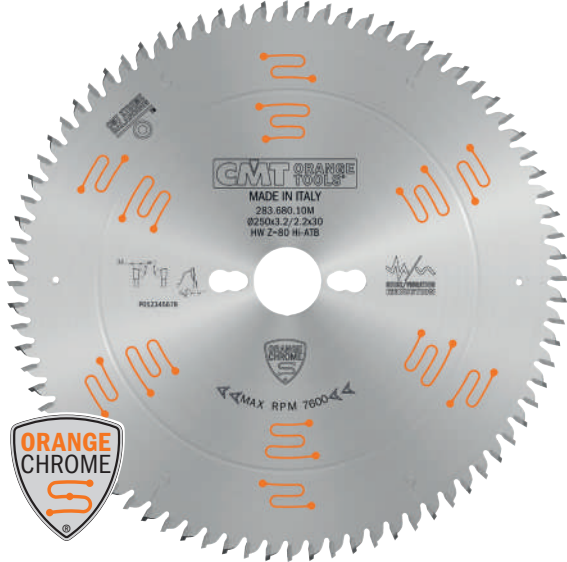

283.6 ORANGE CHROME®



WOOD

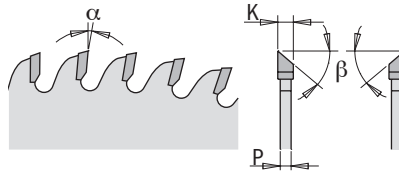

MACHINES

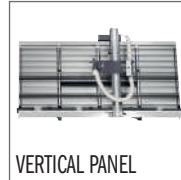

Blade diameter compatibility is contingent on machine type.

APPLICATIONS



MATERIALS

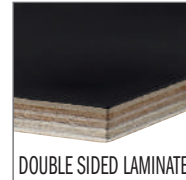
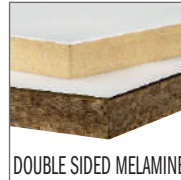

D mm	B mm	PIN HOLE 	Z	K mm	P mm	α	β		ORDER NO.
250	30	COMBI3	80	3,2	2,2	-2° Neg.	38° Hi-ATB	1	283.680.10M
300	30	COMBI3	96	3,2	2,2	2°	38° Hi-ATB	1	283.696.12M



283 XTREME

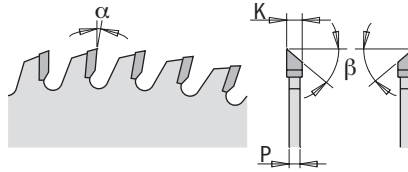

WOOD



MACHINES



MITRE SAW



SLIDE MITRE SAW



RADIAL ARM



TABLE SAW

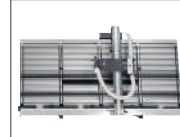

VERTICAL PANEL

Blade diameter compatibility is contingent on machine type.

APPLICATIONS



CROSS

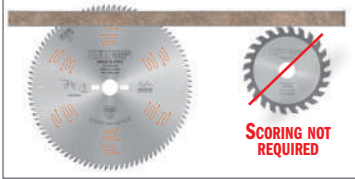

SCORING NOT REQUIRED

MATERIALS



HARDWOOD



SOFTWOOD



PLYWOOD





VENEERED PLYWOOD

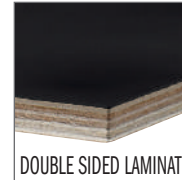

DOUBLE SIDED MELAMINE



DOUBLE SIDED LAMINATE

D mm	B mm	PIN HOLE 	Z	K mm	P mm	α	β		ORDER NO.
220*	30	2/7/42	64	3,2	2,2	-5° Neg.	40° Hi-ATB	1	283.064.09M
250	30	COMBI3	80	3,2	2,2	-2° Neg.	40° Hi-ATB	1	283.080.10M
300	30	COMBI3	96	3,2	2,2	2°	40° Hi-ATB	1	283.096.12M
350	30	COMBI3	108	3,5	2,5	5°	40° Hi-ATB	1	283.108.14M

*Non-Silent Blades

Ultra Fine Finishing - FRAMES



285.5 ORANGE CHROME®



WOOD

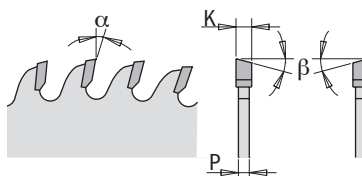

MACHINES

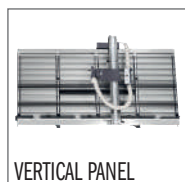

Blade diameter compatibility is contingent on machine type.

APPLICATIONS



MATERIALS

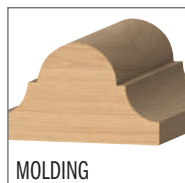
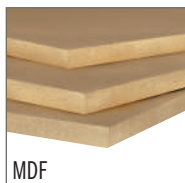

D mm	B mm	PIN HOLE 	Z	K mm	P mm	α	β		ORDER NO.
250	30	COMBI3	80	3,0	2,5	10°	20° ATB	1	285.580.10M
300	30	COMBI3	96	3,0	2,5	10°	20° ATB	1	285.596.12M

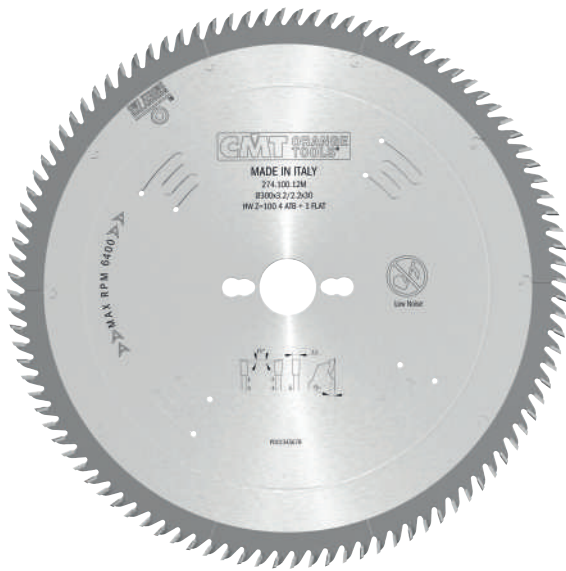

274 XTREME



WOOD

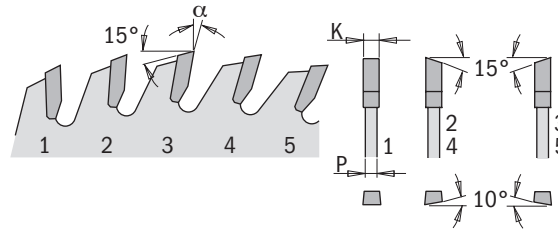

MACHINES



MITRE SAW



SLIDE MITRE SAW



RADIAL ARM



TABLE SAW

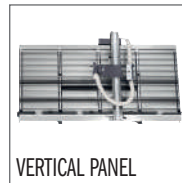

VERTICAL PANEL

Blade diameter compatibility is contingent on machine type.

APPLICATIONS



CROSS

MATERIALS



HARDWOOD



SOFTWOOD



PLYWOOD



VENEERED PLYWOOD

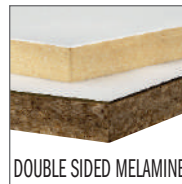

DOUBLE SIDED MELAMINE

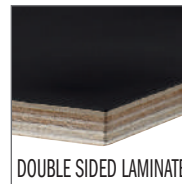

DOUBLE SIDED LAMINATE

D mm	B mm	PIN HOLE ⊕⊕⊕	Z	K mm	P mm	α	β		ORDER NO.
250	30	COMBI3	80	3,2	2,2	15°	1° FLAT + 4° ATB	1	274.080.10M
300	30	COMBI3	100	3,2	2,2	15°	1° FLAT + 4° ATB	1	274.100.12M

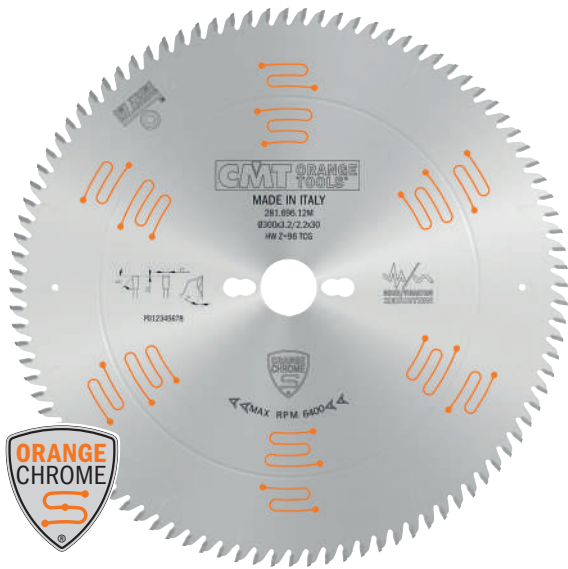

281 ORANGE CHROME®



WOOD

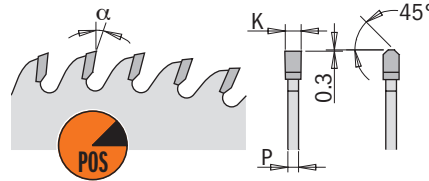

MACHINES

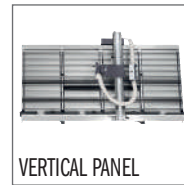

Blade diameter compatibility is contingent on machine type.

APPLICATIONS



MATERIALS

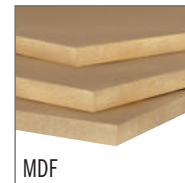

For specific details regarding suggested materials, please check blade label.

D mm	B mm	PIN HOLE ⊕⊕⊕	Z	K mm	P mm	α	β		ORDER NO.
160	20	2/6/32	48	2,2	1,6	4°	TCG	1	281.760.48H ●
190	20 (FESTOOL® FF)	-	54	2,6	1,8	4°	TCG	1	281.790.54FF ●
250	30	COMBI3	80	3,2	2,2	5°	TCG	1	281.680.10M
300	30	COMBI3	72	3,2	2,2	10°	TCG	1	281.672.12M
300	30	COMBI3	96	3,2	2,2	5°	TCG	1	281.696.12M
350	30	COMBI3	84	3,5	2,5	10°	TCG	1	281.684.14M
350	30	COMBI3	108	3,5	2,5	5°	TCG	1	281.708.14M

● Ideal for FESTOOL® & others

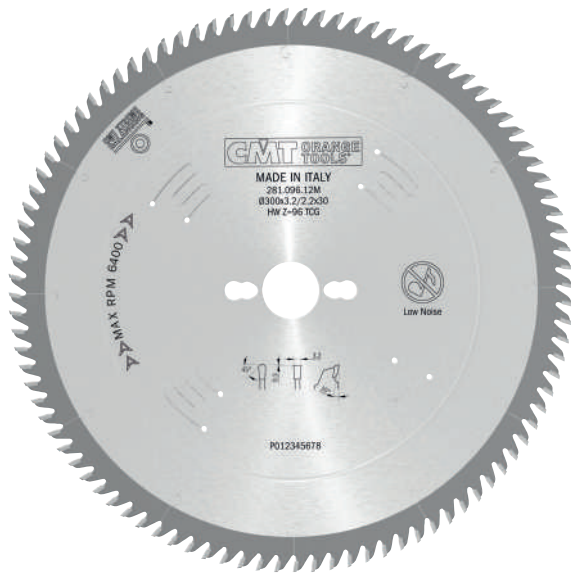

281 XTREME

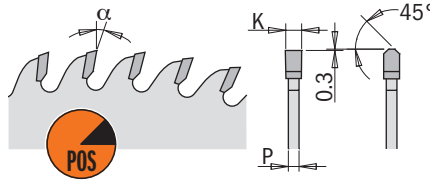

WOOD

MACHINES



Blade diameter compatibility is contingent on machine type.

APPLICATIONS



MATERIALS

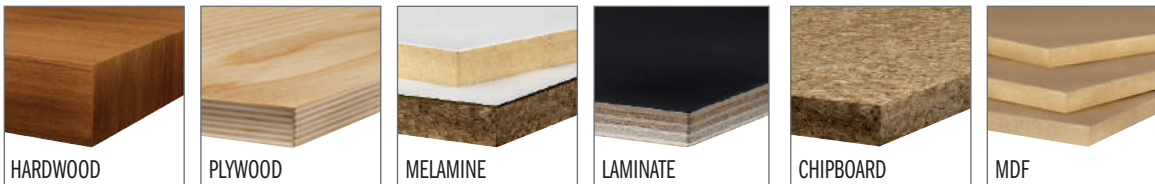

D mm	B mm	PIN HOLE ⊕⊕⊕	Z	K mm	P mm	α	β		ORDER NO.
250	30	COMBI3	60	3,2	2,2	10°	TCG	1	281.060.10M
250	30	COMBI3	80	3,2	2,2	10°	TCG	1	281.080.10M
300	30	COMBI3	72	3,2	2,2	10°	TCG	1	281.072.12M
300	30	COMBI3	96	3,2	2,2	10°	TCG	1	281.096.12M
350	30	COMBI3	84	3,5	2,5	10°	TCG	1	281.084.14M
350	30	COMBI3	108	3,5	2,5	10°	TCG	1	281.108.14M



295 XTREME



WOOD

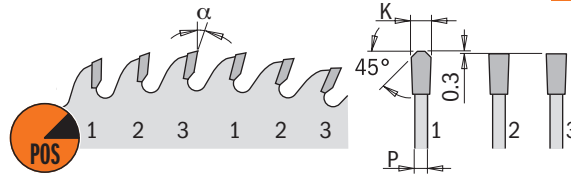

MACHINES



Blade diameter compatibility is contingent on machine type.

APPLICATIONS



MATERIALS

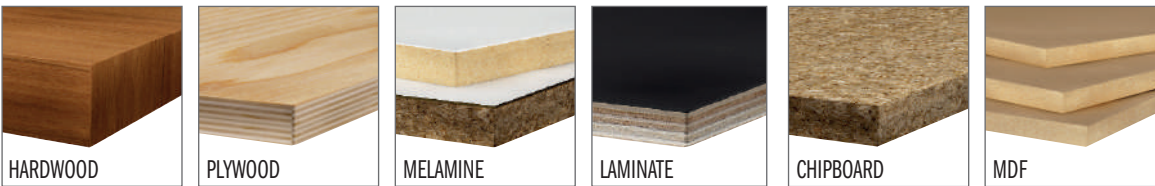

D mm	B mm	PIN HOLE	Z	K mm	P mm	α	β		ORDER NO.
250	30	COMBI3	78	3,2	2,2	10°	FFT	1	295.078.10M
300	30	COMBI3	96	3,2	2,2	10°	FFT	1	295.096.12M
350	30	COMBI3	108	3,5	2,5	10°	FFT	1	295.108.14M

281 XTREME



WOOD

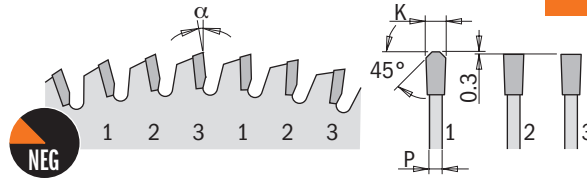

MACHINES



Blade diameter compatibility is contingent on machine type.

APPLICATIONS

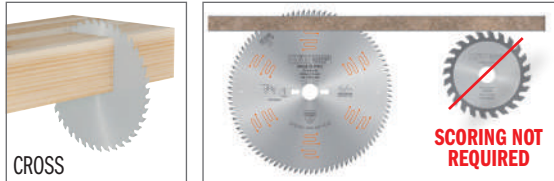

MATERIALS

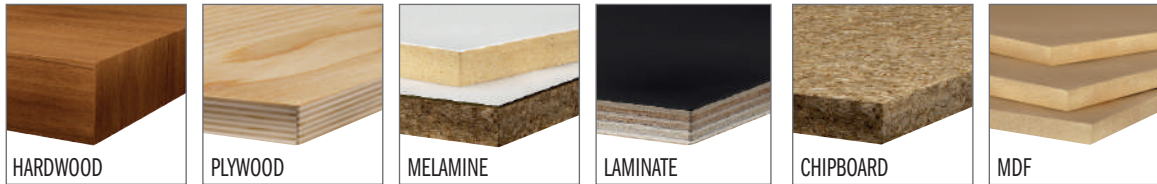

D mm	B mm	PIN HOLE	Z	K mm	P mm	α	β		ORDER NO.
220	30	COMBI3	63	3,2	2,2	-3° Neg.	FFT	1	281.063.09M
250	30	COMBI3	60	3,2	2,2	-3° Neg.	FFT	1	281.061.10M
300	30	COMBI3	72	3,2	2,2	-3° Neg.	FFT	1	281.073.12M



281 ORANGE CHROME®

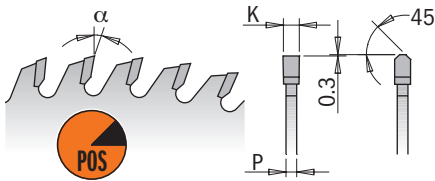
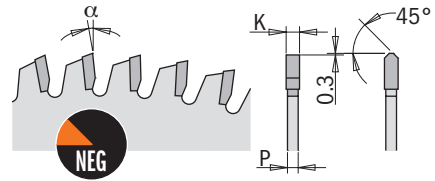

WOOD

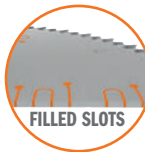

MACHINES

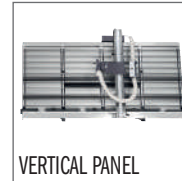

Blade diameter compatibility is contingent on machine type.

APPLICATIONS



MATERIALS

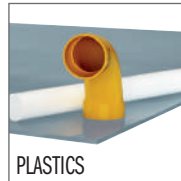
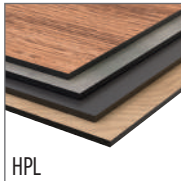

D mm	B mm	PIN HOLE	Z	K mm	P mm	α	β		ORDER NO.
160	20	2/6/32	52	1,8	1,2	-5° Neg.	TCG	1	281.761.52H ●
165	20	2/6/32	52	1,8	1,2	-5° Neg.	TCG	1	281.766.52H ●
168	20	2/6/32	52	1,8	1,2	-5° Neg.	TCG	1	281.768.52H ●
190	30	2/7/42	54	2,6	1,8	4°	TCG	1	281.790.54M ●
210	30	2/7/42	60	2,6	1,6	-3° Neg.	TCG	1	281.810.60M ●
216	30	2/7/42	64	2,6	1,6	-3° Neg.	TCG	1	281.816.64M ●
250	30	COMBI3	80	3,2	2,2	-3° Neg.	TCG	1	281.681.10M
300	30	COMBI3	96	3,2	2,2	-3° Neg.	TCG	1	281.697.12M

● Ideal for **FESTOOL®** & others

281 INDUSTRIAL



WOOD



MACHINES

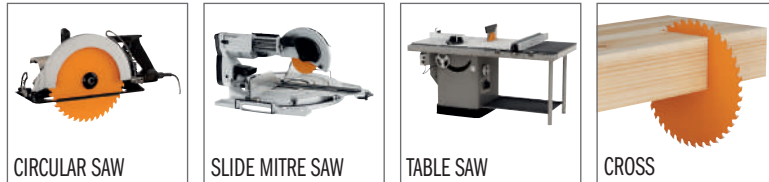

Blade diameter compatibility is contingent on machine type.

MATERIALS



For specific details regarding suggested materials, please check blade label.

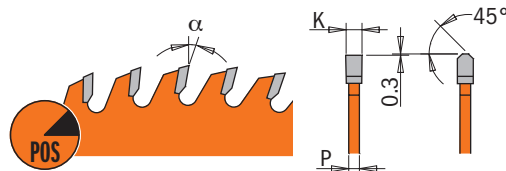

POSITIVE

D mm	B mm	PIN HOLE	Z	K mm	P mm	α	β	APPLICATIONS		ORDER NO.
160	20 (VIRUTEX®)	4/7/32 45°	40	2,2	1,6	10°	TCG	Finish	10	281.160.40H
160	20	2/6/32	48	2,2	1,6	5°	TCG	Fine Finish	10	281.160.48H ●
200	30	2/7/42	64	3,2	2,2	10°	TCG	Fine Finish	10	281.064.08M
220	30	2/7/42	64	3,2	2,2	10°	TCG	Fine Finish	10	281.064.09M
225	30	2/7/42	64	2,6	1,8	4°	TCG	Fine Finish	10	281.225.64M ●

● Ideal for **FESTOOL®** & others

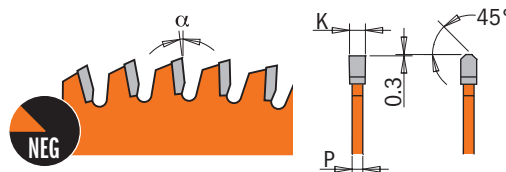

NEGATIVE

D mm	B mm	PIN HOLE	Z	K mm	P mm	α	β	APPLICATIONS		ORDER NO.
160	20	2/6/32	56	2,2	1,6	-3° Neg.	TCG	Ultra Finish	10	281.161.56H ●
165	20	2/6/32	56	2,2	1,6	-3° Neg.	TCG	Ultra Finish	10	281.166.56H
260	30	COMBI3	64	2,5	1,8	-3° Neg.	TCG	Finish	5	281.065.11M ●

● Ideal for **FESTOOL®** & others

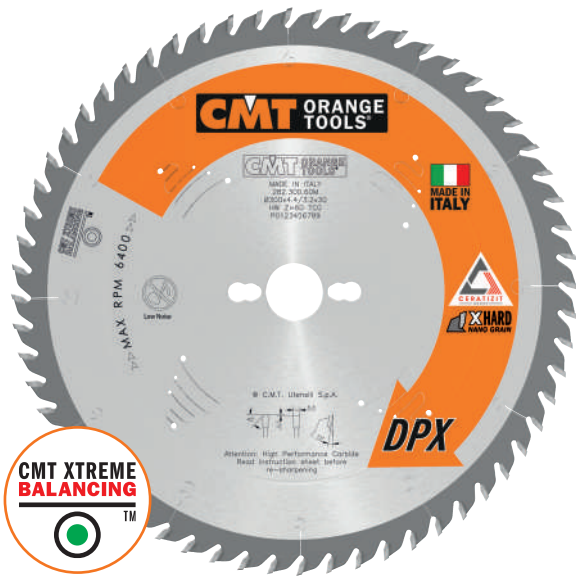

282 XTREME

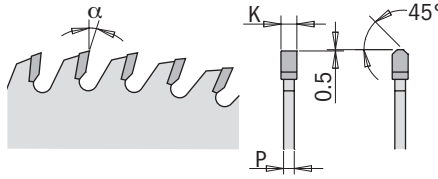

WOOD



NANO GRAIN CARBIDE

Cutting teeth are made from an exclusive high-pressure sintering and the use of nano grain carbide powders make the material free of porosity, extremely hard and compact, with excellent tenacity that ensures greater resistance to wear as compared to others and exceptional durability.

% METERS CUT ON CHIPBOARD PANELS

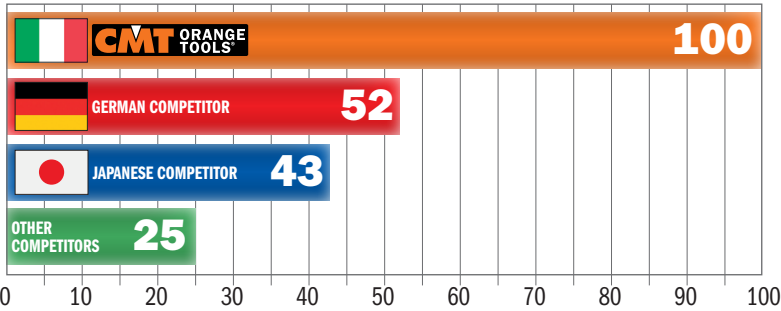

UP TO 4X THAN COMPETITORS



HOW TO RE-SHARPEN A CMT DPX BLADE



MACHINES

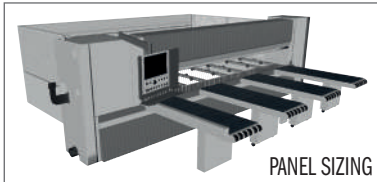

MATERIALS

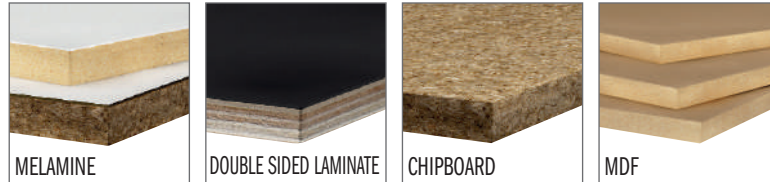

D mm	B mm	PIN HOLE	Z	K mm	P mm	α	β		ORDER NO.
300	30	COMBI3	60	4,4	3,2	15°	TCG	1	282.300.60M
300	80	COMBI5	60	4,4	3,2	16°	TCG	1	282.300.60W
320	65	2/9/100 + 2/14/110	60	4,4	3,2	15°	TCG	1	282.320.60J
320	65	2/9/100 + 2/14/110	72	4,4	3,2	15°	TCG	1	282.320.72J
350	30	COMBI3	72	4,4	3,2	15°	TCG	1	282.350.72M
350	60	2/9/100 + 2/14/110	72	4,4	3,2	15°	TCG	1	282.350.72U
350	75	3/7/100 + 4/15/105	72	4,4	3,2	15°	TCG	1	282.350.72X
350	80	COMBI5	72	4,4	3,2	16°	TCG	1	282.350.72W
355	65	2/9/100 + 2/9/110	72	4,4	3,2	16°	TCG	1	282.355.72J
380	60	2/14/100	72	4,4	3,2	15°	TCG	1	282.380.72U2
380	60	COMBI7	72	4,8	3,5	15°	TCG	1	282.380.72U
380	80	COMBI5	72	4,4	3,2	16°	TCG	1	282.380.72W
400	30	COMBI3	72	4,4	3,2	15°	TCG	1	282.400.72M
400	75	4/15/105	72	4,4	3,2	16°	TCG	1	282.400.72X
400	80	COMBI5	72	4,4	3,2	15°	TCG	1	282.400.72W
450	60	COMBI7	72	4,8	3,5	15°	TCG	1	282.450.72U



WOOD

289 X-TREME

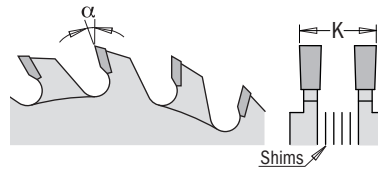

TIPS: suggested for machines without vertical regulation of scoring blade.



MACHINES



APPLICATIONS

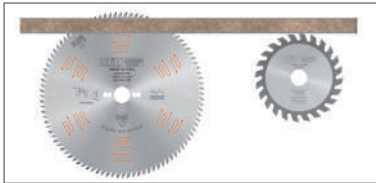

MATERIALS



D mm	B mm	PIN HOLE	Z	K mm	α	β		ORDER NO.
70	20	-	8+8	2,8-3,6	12°	FLAT	10	289.070.16H
80	20	-	10+10	2,8-3,6	12°	FLAT	10	289.080.20H
100	20	-	10+10	2,8-3,6	12°	FLAT	10	289.100.20H
100	22	-	10+10	2,8-3,6	12°	FLAT	10	289.100.20K
120	20	-	12+12	2,8-3,6	12°	FLAT	10	289.120.24H
120	22	-	12+12	2,8-3,6	12°	FLAT	10	289.120.24K
120	50	-	12+12	2,8-3,6	12°	FLAT	10	289.120.24T ●
125	20	-	12+12	2,8-3,6	12°	FLAT	10	289.125.24H
125	22	-	12+12	2,8-3,6	12°	FLAT	10	289.125.24K

Spare parts

	PVC SHIMS
299.000.05H	299.000.05H
299.000.02K	299.000.02K
299.000.02K	299.000.02K
299.000.02K	299.000.02K
299.000.02K	299.000.02K
299.000.02K	299.000.02K

● Ideal for **ALTENDORF® Rapido System**



288 XTREME



WOOD

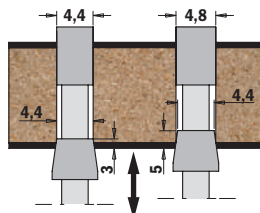
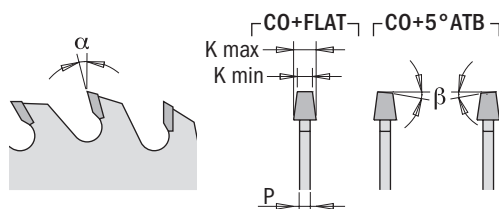

TIPS: suggested for machines with vertical regulation of scoring blade.

Suggested for use with thick kerf or panel sizing blade.

MACHINES



APPLICATIONS

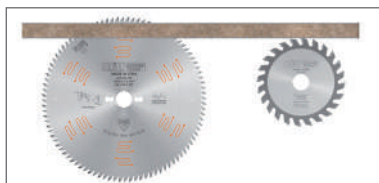

MATERIALS

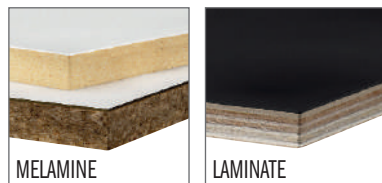

D mm	B mm	PIN HOLE	Z	K mm	P mm	α	β		ORDER NO.
80	20	-	12	3,1-3,6	2,2	10°	CO+FLAT	10	S288.080.12H
100	20	-	20	3,1-4,0	2,5	5°	CO+5° ATB	10	288.100.20H
100	22	-	20	3,1-4,0	2,5	5°	CO+5° ATB	10	288.100.20K
120	20	-	24	3,1-4,0	2,5	5°	CO+5° ATB	10	288.120.24H
120	20	-	24	3,4-4,2	2,5	5°	CO+5° ATB	10	288.120.24H1
120	22	-	24	3,1-4,0	2,5	5°	CO+5° ATB	10	288.120.24K
125	20	-	24	3,1-4,0	2,5	5°	CO+5° ATB	10	288.125.24H
125	20	-	24	3,4-4,2	2,5	5°	CO+5° ATB	10	288.125.24H1
125	20	-	24	4,3-5,5	3,2	10°	CO+FLAT	10	288.125.24H2
125	22	-	24	3,1-4,0	2,5	5°	CO+5° ATB	10	288.125.24K
125	45	-	24	4,3-5,5	3,2	10°	CO+FLAT	10	288.125.24Q
150	45	3/11/70	36	4,3-5,5	3,2	10°	CO+FLAT	5	288.150.36Q
160	45	3/11/70	36	4,3-5,5	3,2	10°	CO+FLAT	5	288.160.36Q
160	55	3/7/66 + 3/6/84	36	4,3-5,5	3,2	10°	CO+FLAT	5	288.160.360
180	20	-	36	4,3-5,5	3,2	10°	CO+FLAT	5	Y288.180.36H ■
180	30	COMBI3	36	4,5-5,5	3,2	10°	CO+FLAT	5	288.180.36M
180	45	-	36	4,3-5,5	3,2	8°	CO+5° ATB	5	288.180.36Q2
180	45	-	36	4,7-6,0	3,5	10°	CO+FLAT	5	288.180.36Q
180	55	-	36	5,0-6,2	3,5	10°	CO+FLAT	5	288.180.360 ■
180	50	3/12,5/80	44	4,3-5,5	3,2	10°	CO+FLAT	5	288.180.44T
200	20	-	36	4,4-5,3	3,2	10°	CO+FLAT	5	288.200.36H
200	45	-	36	4,7-6,0	3,5	10°	CO+FLAT	5	288.200.36Q
200	45	-	36	4,3-5,5	3,2	10°	CO+FLAT	5	Y288.200.36Q2
200	65	2/9/100 + 2/9/110	36	4,4-5,3	3,2	10°	CO+FLAT	5	288.200.36J
215	50	3/15/80	42	4,3-5,5	3,2	8°	CO+FLAT	5	288.215.42T
300	50	3/15/80	48	4,3-5,5	3,2	10°	CO+FLAT	5	288.300.48T
300	65	2/9/100 + 2/9/110	72	4,3-5,5	3,2	10°	CO+FLAT	5	288.300.72J

■ Until stock last

DP - Laminated & Chipboard - LONG LIFE



237 XTREME



WOOD

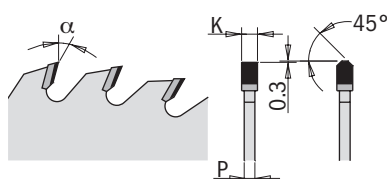

50X
LONGER LIFE
THAN CARBIDE

MACHINES

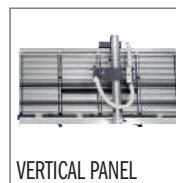

Blade diameter compatibility is contingent on machine type.

High-quality nickel-plated saw blades with anti-friction and anti-corrosion properties.

APPLICATIONS



MATERIALS

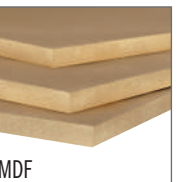

D mm	B mm	PIN HOLE	Z	K mm	P mm	α	β		ORDER NO.
250	30	COMBI3	48	3,2	2,2	10°	TCG	1	237.048.10M
300	30	COMBI3	60	3,2	2,2	10°	TCG	1	237.060.12M
300	30	COMBI3	96	3,2	2,2	15°	TCG	1	237.096.12M
350	30	COMBI3	72	3,5	2,4	15°	TCG	1	237.072.14M

DP - Conical Scoring - LONG LIFE



238 XTREME



WOOD

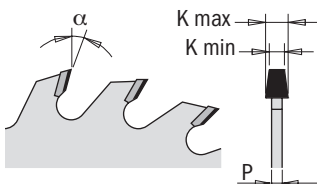

50X
LONGER LIFE
THAN CARBIDE

MACHINES



APPLICATIONS

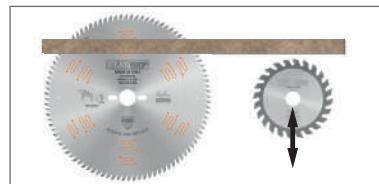

MATERIALS

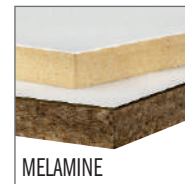

D mm	B mm	PIN HOLE	Z	K mm	P mm	α	β		ORDER NO.
120	20	-	20	3,1-3,7	2,2	5°	CONICAL	1	238.120.20H
125	20	-	20	3,1-3,7	2,2	5°	CONICAL	1	238.125.20H



LEUCO
Patent Pending

235 TREME ALL-AROUND

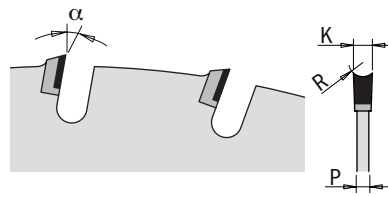

50X
LONGER LIFE
THAN CARBIDE



MACHINES

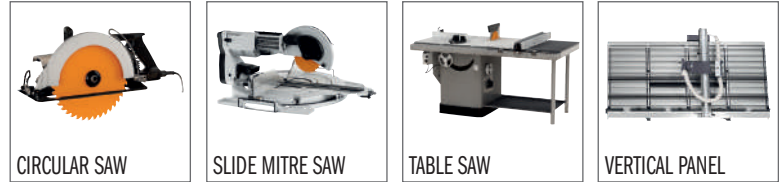

Blade diameter compatibility is contingent on machine type.

MATERIALS

NO LIMITS: CUT ALL WITH ONE BLADE!

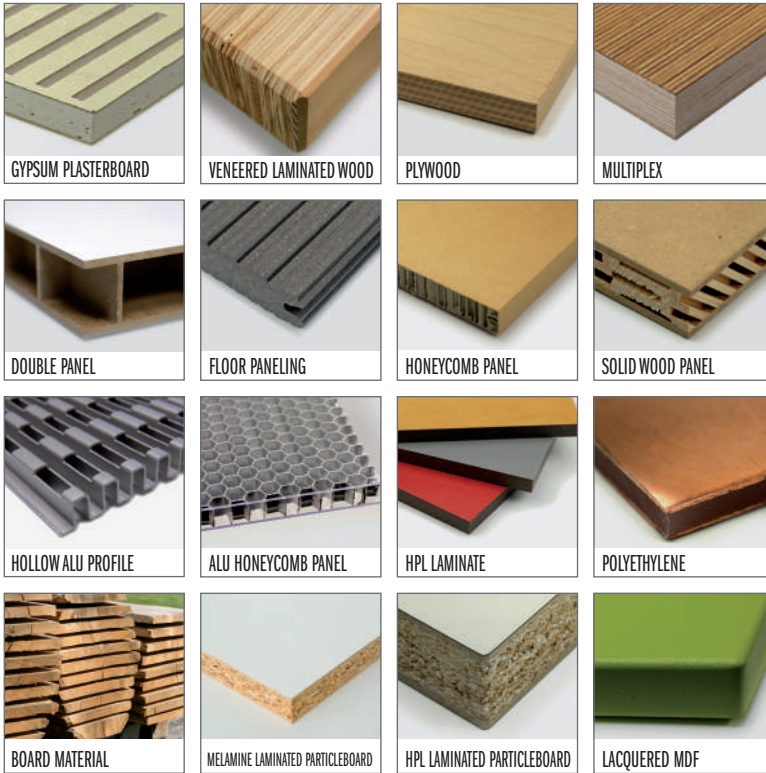

TREME-NOISELESS

Thanks to the new minimization of gullets design this blade succeeded in reducing the noise of idling by up to 15 dB(A) compared to conventional carbide saw blades. With a noise level of just around 70dB(A) when idling, the wearing of hearing protection is outdated.

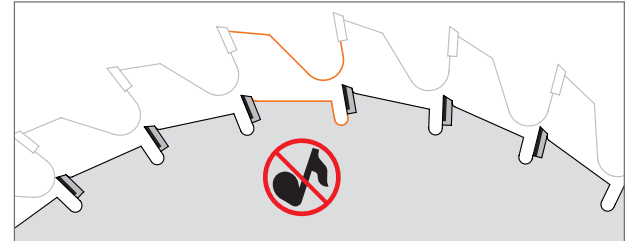

TREME-ALL-AROUND

New industry standard with universal application in countless materials and suitable for all chop saws and portable machines, table and vertical panel sizing saws, CNCs and through-feed installations

TREME-QUALITY

The special hollow back tooth configuration (HR) guarantees an excellent cutting quality.

TREME-FAST

The teeth are surprisingly thin! The cutting width is a mere 2,5 mm and they generate noticeably lower cutting pressure and therefore also require less power during usage. Resharpenable max 2 times.

TREME-LIFETIME

The lifetime is 20X longer than carbide blades thanks to the diamond tips.

RECOMMENDED USE

We recommend the use of a splitting wedge between **2,0** and **2,4**mm in thickness.

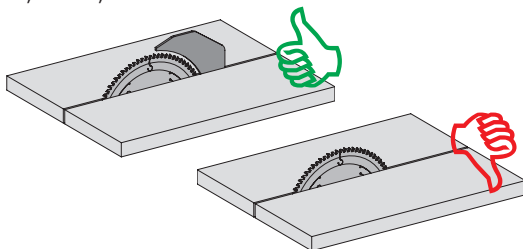

LONGER LIFETIME THANKS TO DIAMOND TIPS Clean your circular saw blades on a regular basis. You will profit from a long-lasting and precise cutting quality and maximize the lifetime of your innovative saw blades many times over.

!

- It is not recommended to use the saw blades for longitudinal cuts in soft wood and material thicknesses of more than 40mm.
- Do not cut materials with nails, stone and metal parts.
- Chip-free cuts can only be guaranteed in combination with a suitable scoring saw blade.

D mm	B mm	PIN HOLE	Z	K mm	P mm	α	β		ORDER NO.
160	20	2/6/32	20	2,2	1,6	10°	HR	1	235.160.20H
190	30	2/7/42	24	2,5	2,0	10°	HR	1	235.190.24M
216	30	2/7/42	30	2,5	2,0	10°	HR	1	235.216.30M
250	30	COMBI3	36	2,5	2,0	10°	HR	1	235.250.36M
300	30	COMBI3	44	2,5	2,0	10°	HR	1	235.300.44M

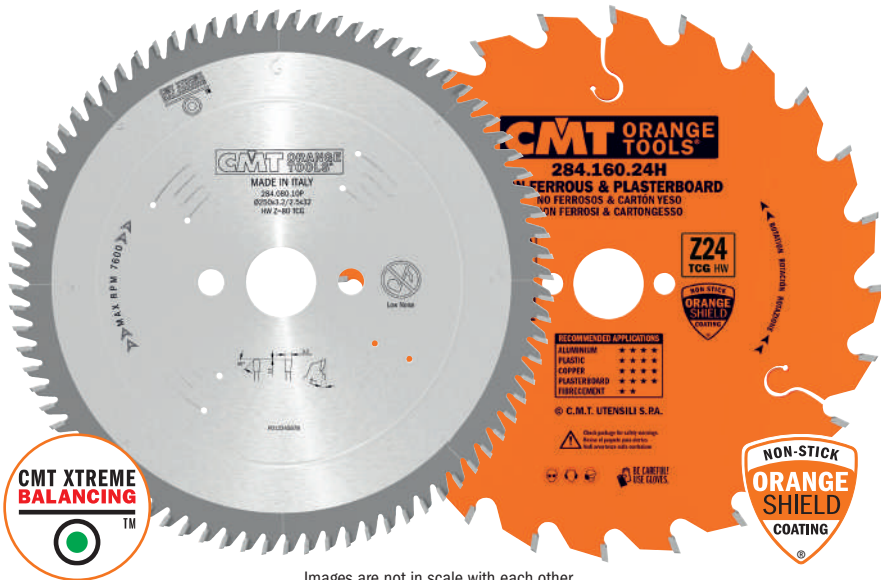

284



NON-FERROUS

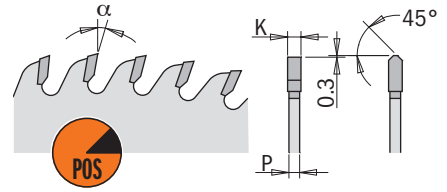

Images are not in scale with each other.

MACHINES

*WITH MEC/MAN WORKPIECE CLAMPING

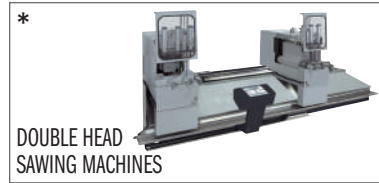

Blade diameter compatibility is contingent on machine type.

MATERIALS

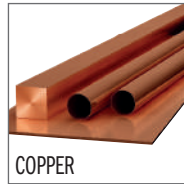
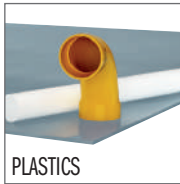

For specific details regarding suggested materials, please check blade label.

284 INDUSTRIAL

NON-STICK ORANGE SHIELD COATING®



D mm	B mm	PIN HOLE 	Z	K mm	P mm	α	β		ORDER NO.
160	20	2/6/32	24	2,2	1,6	5°	TCG	10	284.160.24H ●
190	30	2/7/42	30	2,6	2,2	5°	TCG	10	284.190.30M
216	30	2/7/42	40	2,6	2,2	5°	TCG	10	284.216.40M ●

● Ideal for FESTOOL® & others

284 XTREME



D mm	B mm	PIN HOLE 	Z	K mm	P mm	α	β		ORDER NO.
250	32	2/12/64	80	3,2	2,5	6°	TCG	1	284.080.10P
300	32	2/12/64	96	3,2	2,5	6°	TCG	1	284.096.12P
350	32	2/12/64	84	3,6	3,0	6°	TCG	1	284.092.14P
350	32	2/12/64	108	3,6	3,0	6°	TCG	1	284.108.14P
400	32	2/12/64	96	4,0	3,2	6°	TCG	1	284.096.16P
420	32	2/12/64	96	3,8	3,2	6°	TCG	1	284.096.17P
450	30	2/10/60	108	4,2	3,5	6°	TCG	1	284.108.18M
450	32	2/12/64	108	4,2	3,5	6°	TCG	1	284.108.18P
500	30	2/10/60	120	4,3	3,5	10°	TCG	1	284.120.20M
500	32	2/12/64	120	4,3	3,5	10°	TCG	1	284.120.20P

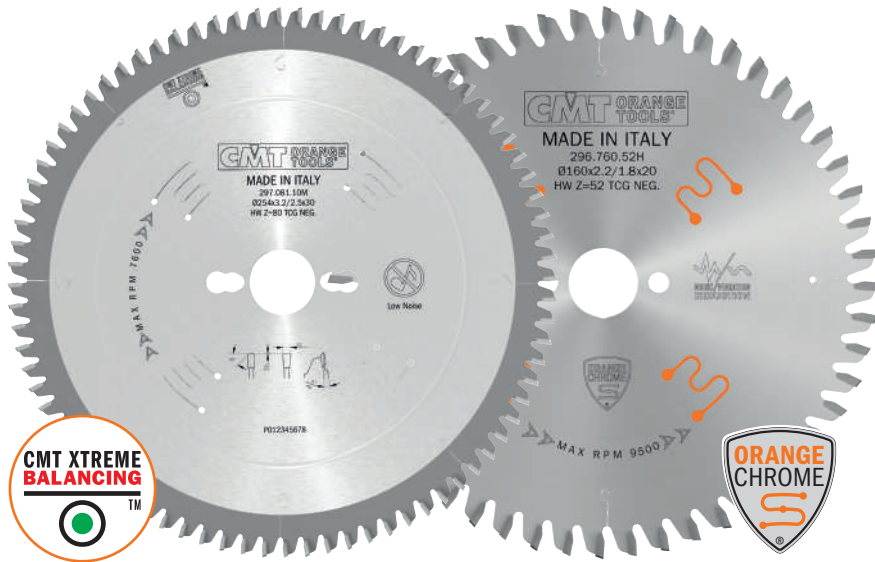

296-297



NON-FERROUS

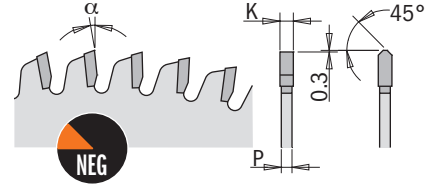

Images are not in scale with each other.

MACHINES



Blade diameter compatibility is contingent on machine type.

MATERIALS

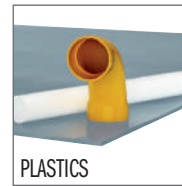
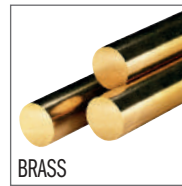
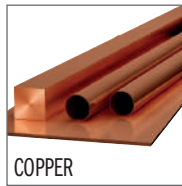

D mm	B mm	PIN HOLE	Z	K mm	P mm	α	β		ORDER NO.	ORDER NO.
160	20	2/6/32	52	2,2	1,8	-5° Neg.	TCG	1	296.760.52H	
160	20	2/6/32	52	1,8	1,2	-5° Neg.	TCG	1	296.761.52H	
168	20	2/6/32	52	1,8	1,2	-5° Neg.	TCG	1	296.768.52H	
216	30	2/7/42	64	2,3	1,6	0°	TCG	1	297.816.64M	
250	30	COMBI3	80	3,2	2,5	-6° Neg.	TCG	1		297.080.10M
250	32	2/12/64	80	3,2	2,5	-6° Neg.	TCG	1		297.080.10P
254	30	COMBI3	80	3,2	2,5	-6° Neg.	TCG	1		297.081.10M
260	30	COMBI3	80	3,2	2,5	-6° Neg.	TCG	1		297.080.11M
280	30	COMBI3	64	3,2	2,5	-6° Neg.	TCG	1		297.064.11M
300	30	COMBI3	96	3,2	2,5	-6° Neg.	TCG	1		297.096.12M
300	32	2/12/64	96	3,2	2,5	-6° Neg.	TCG	1		297.096.12P
305	30	COMBI3	96	3,2	2,5	-6° Neg.	TCG	1		297.096.13M
315	30	COMBI3	96	3,2	2,5	-6° Neg.	TCG	1		297.096.23M
330	30	COMBI3	96	3,6	3,0	-6° Neg.	TCG	1		297.096.33M
330	32	COMBI3	96	3,6	3,0	-6° Neg.	TCG	1		297.096.33P
350	30	COMBI3	108	3,6	3,0	-6° Neg.	TCG	1		297.108.14M
350	32	4/12/64	108	3,6	3,0	-6° Neg.	TCG	1		297.108.14P
400	30	2/10/60	120	4,0	3,2	-6° Neg.	TCG	1		297.120.16M
400	32	4/12/64	96	4,0	3,2	-6° Neg.	TCG	1		297.120.16P
400	32	4/12/64	120	4,0	3,2	-6° Neg.	TCG	1		297.120.16P
450	30	2/10/60	96	4,2	3,5	-6° Neg.	TCG	1		297.108.18M
450	30	2/10/60	120	4,2	3,5	-6° Neg.	TCG	1		Y297.140.18M
450	32	2/12/64	96	4,2	3,5	-6° Neg.	TCG	1		297.108.18P
450	32	4/12/64	120	4,2	3,5	-6° Neg.	TCG	1		297.120.18P
500	30	2/10/60	120	4,3	3,5	-6° Neg.	TCG	1		297.120.20M
500	32	2/12/64	120	4,3	3,5	-6° Neg.	TCG	1		297.120.20P

● Ideal for FESTOOL® & others

© Brand names mentioned in CMT products are the property of their respective owners (see back cover)



296-297 INDUSTRIAL



NON-FERROUS

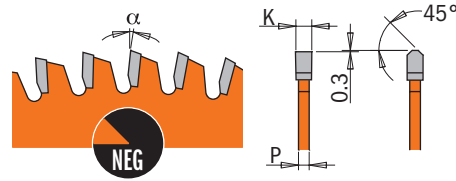

MACHINES

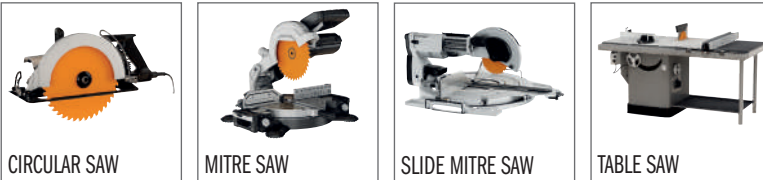

Blade diameter compatibility is contingent on machine type.

MATERIALS

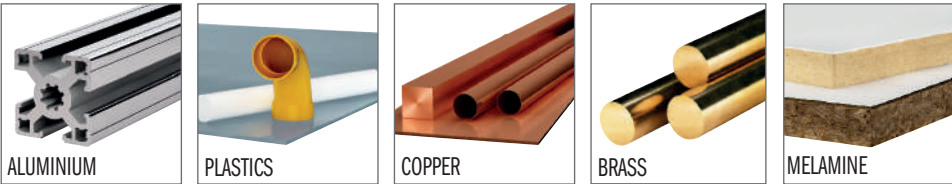

D mm	B mm	PIN HOLE 	Z	K mm	P mm	α	β		ORDER NO.
120	20	2/5,5/30	36	1,8	1,2	-6° Neg.	TCG	10	296.120.36H
160	20	2/6/32	40	2,2	1,6	-6° Neg.	TCG	10	296.160.40H ●
160	20	2/6/32	56	2,2	1,6	-6° Neg.	TCG	10	296.160.56H ●
165	20	2/6/32	40	2,2	1,6	-6° Neg.	TCG	10	296.165.40H
165	20	2/6/32	56	2,2	1,6	-6° Neg.	TCG	10	296.165.56H
180	20	2/6/32	40	2,8	2,2	-6° Neg.	TCG	10	296.180.40H
190	30	2/7/42	40	2,8	2,2	-6° Neg.	TCG	10	296.190.40M
190	30	2/7/42	64	2,8	2,2	-6° Neg.	TCG	10	296.190.64M
190	20 (FESTOOL® FF)	Key 5/7/2,5	64	2,8	2,2	-6° Neg.	TCG	10	296.190.64FF ●
200	30	COMBI3	48	2,8	2,2	-6° Neg.	TCG	10	296.200.48M
210	30	2/7/42	48	2,8	2,2	-6° Neg.	TCG	10	296.210.48M ●
210	30	2/7/42	64	2,8	2,2	-6° Neg.	TCG	10	296.210.64M ●
216	30	2/7/42	64	2,8	2,2	-6° Neg.	TCG	10	297.064.09M ●
216	30	2/7/42	80	2,8	2,2	-6° Neg.	TCG	10	297.080.09M ●
225	30	2/7/42	64	2,8	2,2	-6° Neg.	TCG	10	296.225.64M ●
230	30	2/7/42	48	2,8	2,2	-6° Neg.	TCG	10	296.230.48M ●
235	30	2/7/42	48	2,8	2,2	-6° Neg.	TCG	10	296.235.48M

● Ideal for FESTOOL® & others



276 ITK PLUS®



NON-FERROUS

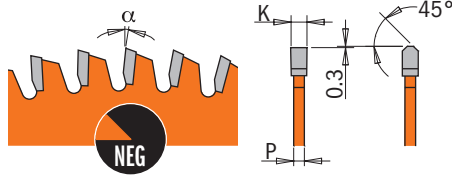

MACHINES

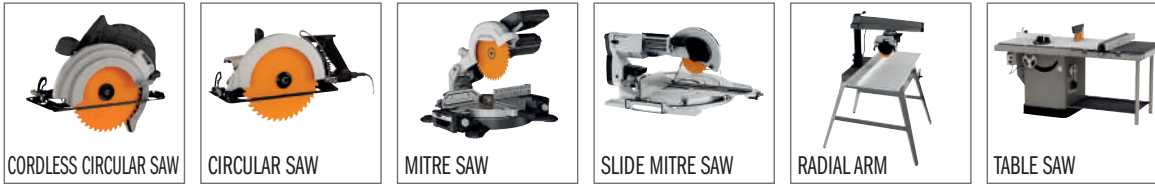

Blade diameter compatibility is contingent on machine type.

MATERIALS

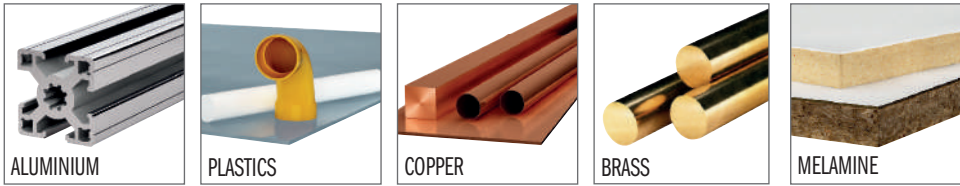

D mm	B mm	PIN HOLE	Z	K mm	P mm	α	β		ORDER NO.
new 140	20	2/6/32,5	48	1,8	1,2	-6° Neg.	TCG	10	276.140.48H
160	20 (+16)	2/6/32	48	1,8	1,2	-6° Neg.	TCG	10	276.160.48H ●
new 165	20 (+15,87)	2/6/32	56	1,8	1,2	-6° Neg.	TCG	10	276.165.56H
new 168	20	2/6/32	52	1,8	1,2	-5° Neg.	TCG	10	276.168.52H ●
184	20 (+16+15,87)	2/7/42	48	1,8	1,2	-6° Neg.	TCG	10	276.184.48H
190	30 (+20+16)	2/7/42	64	1,8	1,2	-6° Neg.	TCG	10	276.190.64M
210	30 (+25)	2/7/42	64	1,8	1,2	-6° Neg.	TCG	10	276.210.64M ●
216	30	2/7/42	64	2,2	1,6	-6° Neg.	TCG	10	276.216.64M ●
250	30	COMBI3	80	2,6	1,8	-6° Neg.	TCG	10	276.250.80M
300	30	COMBI3	96	2,8	2,0	-6° Neg.	TCG	5	276.300.96M
305	30	COMBI3	96	2,8	2,0	-6° Neg.	TCG	5	276.305.96M

● Ideal for **FESTOOL®** & others

MATERIALS	COATING TYPE	
STEEL (<500 N/mm ²)	★ ★	★ ★ ★ ★
STEEL (<800 N/mm ²)	★ ★	★ ★ ★
STEEL (<1200 N/mm ²)	★ ★	★ ★ ★ ★
STAINLESS STEEL	★ ★	★ ★ ★ ★
CAST IRON	★ ★	★ ★ ★ ★
ALUMINIUM/ALLOY AL.	★ ★	★ ★ ★ ★
TITANIUM	★	★ ★
BRONZE	NOT RECOMMENDED	★ ★ ★ ★
COPPER	NOT RECOMMENDED	★ ★ ★
BRASS	NOT RECOMMENDED	★ ★ ★
TECHNICAL INFO	VAPO	TiCN
COLOR	BLACK	BROWN - RED
HARDNESS (HV)	800	3200
THICKNESS (µm)	2 - 4	2 - 4
COEFFICIENT OF FRICTION	0.6	0.2
MAX. WORKING TEMPERATURE	350°C	450°C

SUGGESTED SPEED (BW - C/HZ)	
MATERIALS	V (m/min.) MIN. ~ MAX
STEEL (<500 N/mm ²):	30 ~ 60
STEEL (<800 N/mm ²):	25 ~ 40
STEEL (<1200 N/mm ²):	15 ~ 30
STAINLESS STEEL:	15 ~ 30
CAST IRON:	25 ~ 50
ALUMINIUM/ALLOY AL.:	500 ~ 700
TITANIUM:	15 ~ 20
BRONZE:	200 ~ 300
COPPER:	200 ~ 400
BRASS:	400 ~ 600

$$RPM = \frac{1000 \times V \text{ (m/min.)}}{3,14 \times D \text{ (mm)}}$$



227 HSS LINE



METAL & STEEL

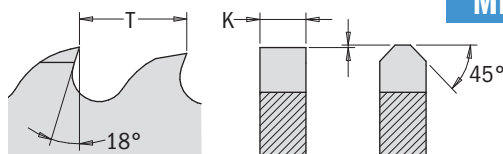

SHARPENING

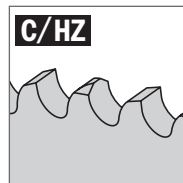

APPLICATIONS



D mm	B mm	PIN HOLE 	Z	K mm	PITCH T	β	COATING 	ORDER NO.
250	32	2/8/45+2/9/50+2/11/63	128	2,0	T6	C/HZ	VAPO	227.250.128P
275	32	2/8/45+2/9/50+2/11/63	140	2,5	T6	C/HZ	VAPO	227.275.140P
300	32	2/8/45+2/9/50+2/11/63	160	2,5	T6	C/HZ	VAPO	227.300.160P
315	32	2/8/45+2/9/50+2/11/63	160	2,5	T6	C/HZ	VAPO	227.315.160P
350	32	2/8/45+2/9/50+2/11/63	180	2,5	T6	C/HZ	VAPO	227.350.180P



227 HSS LINE



METAL & STEEL

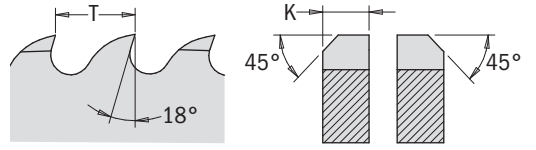

SHARPENING

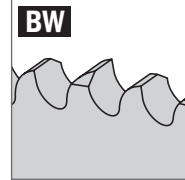

APPLICATIONS



D mm	B mm	PIN HOLE ⊕⊕⊕	Z	K mm	PITCH T	β	COATING 	ORDER NO.
200	32	2/8/45+2/9/50+2/11/63	160	1,8	T4	BW	VAPO	227.200.160P
225	32	2/8/45+2/9/50+2/11/63	180	1,9	T4	BW	VAPO	227.225.180P
250	32	2/8/45+2/9/50+2/11/63	160	2,0	T5	BW	VAPO	227.250.160P
250	32	2/8/45+2/9/50+2/11/63	200	2,0	T4	BW	VAPO	227.250.200P
275	32	2/8/45+2/9/50+2/11/63	220	2,5	T4	BW	VAPO	227.275.220P
300	32	2/8/45+2/9/50+2/11/63	220	2,5	T4	BW	VAPO	227.300.220P
315	32	2/8/45+2/9/50+2/11/63	240	2,5	T4	BW	VAPO	227.315.240P
350	32	2/8/45+2/9/50+2/11/63	280	2,5	T4	BW	VAPO	227.350.280P

D mm	B mm	PIN HOLE ⊕⊕⊕	Z	K mm	PITCH T	β	COATING 	ORDER NO.
250	32	2/8/45+2/9/50+2/11/63	200	2,0	T4	BW	TiCN	227.250.700P
275	32	2/8/45+2/9/50+2/11/63	220	2,0	T4	BW	TiCN	227.275.722P
275	32	2/8/45+2/9/50+2/11/63	220	2,5	T4	BW	TiCN	227.275.720P
300	32	2/8/45+2/9/50+2/11/63	220	2,0	T4	BW	TiCN	227.300.722P
300	32	2/8/45+2/9/50+2/11/63	220	2,5	T4	BW	TiCN	227.300.720P
315	32	2/8/45+2/9/50+2/11/63	240	2,5	T4	BW	TiCN	227.315.740P
350	32	2/8/45+2/9/50+2/11/63	280	2,5	T4	BW	TiCN	227.350.780P



227 HSS LINE



METAL & STEEL

D mm	B mm	PIN HOLE ⊕⊕⊕	Z	K mm		β	COATING 	ORDER NO.
200	32	2/8/45+2/9/50+2/11/63	0	1,8		Not Sharpened	VAPO	227.200P
225	32	2/8/45+2/9/50+2/11/63	0	1,9		Not Sharpened	VAPO	227.225P
250	32	2/8/45+2/9/50+2/11/63	0	2,0		Not Sharpened	VAPO	227.250P
275	32	2/8/45+2/9/50+2/11/63	0	2,5		Not Sharpened	VAPO	227.275P
300	32	2/8/45+2/9/50+2/11/63	0	2,5		Not Sharpened	VAPO	227.300P
315	32	2/8/45+2/9/50+2/11/63	0	2,5		Not Sharpened	VAPO	227.315P
350	32	2/8/45+2/9/50+2/11/63	0	2,5		Not Sharpened	VAPO	227.350P



226 INDUSTRIAL

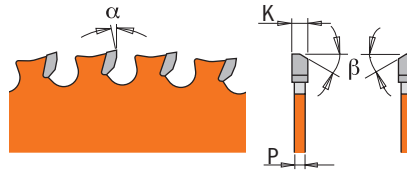

METAL & STEEL

MACHINES



CIRCULAR SAW



MITRE & CHOP MITRE SAW

Blade diameter compatibility is contingent on machine type.

MATERIALS



CHANNELS/STUDS/ANGLES



PLATES/SHEETS/FLAT BARS



EMT CONDUIT

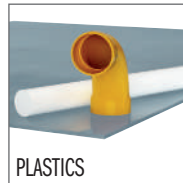

PLASTICS



COPPER/BRASS

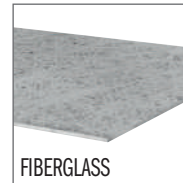

FIBERGLASS

D mm	B mm	PIN HOLE	Z	K mm	P mm	α	β	MAX RPM	Box	ORDER NO.
136	20 (+10)	-	56	1,5	1,2	0°	8° FWF	6000	10	226.136.56H
150	20	-	60	1,6	1,2	0°	8° FWF	6000	10	226.150.60H
160	20 (+16)	2/6/32	60	2,0	1,6	0°	8° FWF	6000	10	226.160.60H ●
165	20	2/6/32	60	1,6	1,2	0°	8° FWF	6000	10	226.165.60H
184	30 (+16+20)	2/7/42	64	2,0	1,6	0°	8° FWF	6000	10	226.184.64M
190	30 (+20)	2/7/42	64	2,0	1,6	0°	8° FWF	6000	10	226.190.64M
210	30	2/7/42	64	2,2	1,8	0°	8° FWF	4500	10	226.210.64M ●
216	30	2/7/42	64	2,2	1,8	0°	8° FWF	3500	10	226.216.64M ●
254	15,87	-	60	2,2	1,8	0°	8° FWF	3000	5	226.060.10
254	30	COMBI3	60	2,2	1,8	0°	8° FWF	3000	5	226.060.10M
305	25,4	-	80	2,2	1,8	0°	8° FWF	2000	5	226.080.12
305	30	COMBI3	80	2,2	1,8	0°	8° FWF	2000	5	226.080.12M
355	25,4	-	90	2,2	1,8	0°	8° FWF	2000	5	226.090.14
355	30	COMBI3	90	2,2	1,8	0°	8° FWF	2000	5	226.090.14M

● Ideal for **FESTOOL**® & others

226 INDUSTRIAL

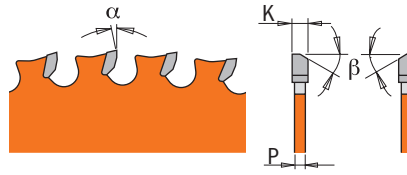
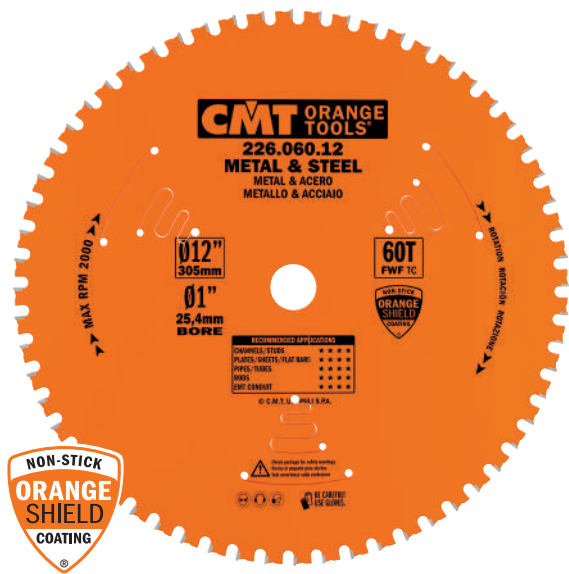

METAL & STEEL

MACHINES



CIRCULAR SAW



MITRE & CHOP MITRE SAW

Blade diameter compatibility is contingent on machine type.

MATERIALS



CHANNELS/STUDS/ANGLES

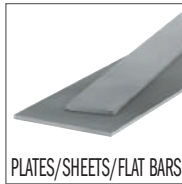

PLATES/SHEETS/FLAT BARS



PIPES/TUBES



RODS



EMT CONDUIT

D mm	B mm	PIN HOLE 	Z	K mm	P mm	α	β	MAX RPM		ORDER NO.
136	10	-	30	1,5	1,2	0°	8° FWF	6000	10	226.030.05
136	20	-	30	1,5	1,2	0°	8° FWF	6000	10	226.030.05H
150	20	-	32	1,6	1,2	0°	8° FWF	6000	10	226.032.06H
160	20	2/6/32	30	2,0	1,6	0°	8° FWF	6000	10	226.030.06H ●
165	15,87	-	36	1,6	1,2	0°	8° FWF	6000	10	226.036.06
165	20	2/6/32	36	1,6	1,2	0°	8° FWF	6000	10	226.036.06H
165	30	2/7/42	36	1,6	1,2	0°	8° FWF	6000	10	226.036.06M
184	15,87	-	48	2,0	1,6	0°	8° FWF	6000	10	226.048.07
190	30	2/7/42	40	2,0	1,6	0°	8° FWF	6000	10	226.040.07M
203	15,87	-	48	2,2	1,8	0°	8° FWF	4500	10	226.048.08
210	30	2/7/42	48	2,2	1,8	0°	8° FWF	4500	10	226.048.08M ●
216	30	2/7/42	48	2,2	1,8	0°	8° FWF	3500	10	226.047.09M ●
235	30	2/7/42	48	2,2	1,8	0°	8° FWF	3500	10	226.048.09M
254	15,87	-	48	2,2	1,8	0°	8° FWF	3000	5	226.048.10
305	25,4	-	60	2,2	1,8	0°	8° FWF	2000	5	226.060.12
355	25,4	-	72	2,2	1,8	0°	8° FWF	2000	5	226.072.14

● Ideal for FESTOOL® & others

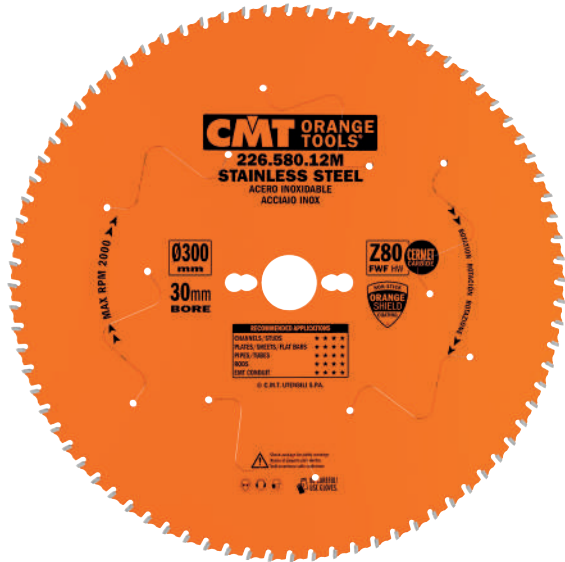

226 INDUSTRIAL

PERFORMANCE

METAL & STEEL

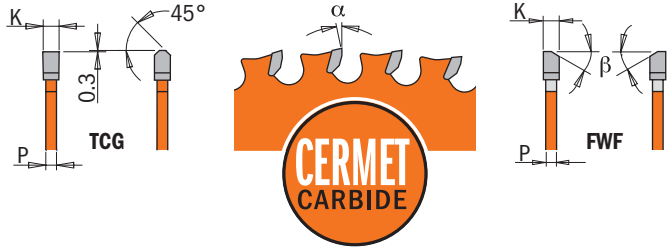

MACHINES

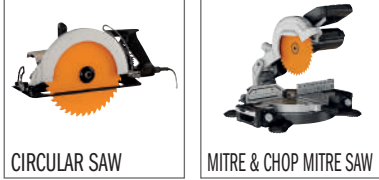

CIRCULAR SAW

MITRE & CHOP MITRE SAW

Blade diameter compatibility is contingent on machine type.

MATERIALS



CHANNELS/STUDS/ANGLES

PLATES/SHEETS/FLAT BARS

PIPES/TUBES

RODS

EMT CONDUIT

Suggested for Stainless steel of common use, such as 302, 303 and 304.

With higher degrees of hardness, performance is not guaranteed (e.g. 316)

D mm	B mm	PIN HOLE	Z	K mm	P mm	α	β	MAX RPM		ORDER NO.
160	20	2/6/32	40	1,8	1,4	0°	TCG	6000	10	226.540.06H ●
184	15,87	-	48	2,0	1,6	0°	TCG	6000	10	226.548.07
190	30	2/7/42	48	1,8	1,4	0°	TCG	6000	10	226.548.07M
216	30	2/7/42	56	1,8	1,4	0°	TCG	3500	10	226.556.09M ●
250	30	COMBI3	72	2,2	1,8	0°	10° FWF	3000	5	226.572.10M
254	15,87	-	72	2,2	1,8	0°	10° FWF	3000	5	226.572.10
300	30	COMBI3	80	2,2	1,8	0°	10° FWF	2000	5	226.580.12M
305	25,4	-	80	2,2	1,8	0°	10° FWF	2000	5	226.580.12
355	25,4	-	90	2,2	1,8	0°	10° FWF	2000	5	226.590.14
355	30	COMBI3	90	2,2	1,8	0°	10° FWF	2000	5	226.590.14M

● Ideal for **FESTOOL**® & others

223 INDUSTRIAL



MULTI-MATERIALS

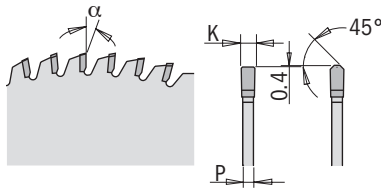

MACHINES



CIRCULAR SAW



MITRE SAW



TABLE SAW



SQUARING

Blade diameter compatibility is contingent on machine type.

MATERIALS



SOLID SURFACE



THICK PLASTICS



D mm	B mm	PIN HOLE 	Z	K mm	P mm	α	β		ORDER NO.
160	20	2/6/32	48	2,2	1,6	0°	MTCG	1	223.048.06H ●
250	30	COMBI3	72	3,2	2,5	0°	MTCG	1	223.072.10M
300	30	COMBI3	84	3,2	2,5	0°	MTCG	1	223.084.12M

● Ideal for **FESTOOL**® & others

Plastics

222 XTREME



MULTI-MATERIALS

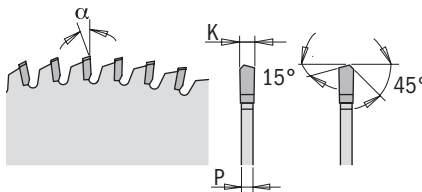

MACHINES



SLIDE MITRE SAW



TABLE SAW



SQUARING

Blade diameter compatibility is contingent on machine type.

MATERIALS

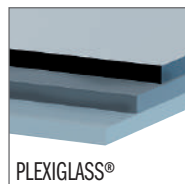

PLEXIGLASS®



THIN PLASTICS



D mm	B mm	PIN HOLE 	Z	K mm	P mm	α	β		ORDER NO.
250	30	COMBI3	80	2,8	2,2	-3° Neg.	MATB	1	222.080.10M
300	30	COMBI3	96	2,8	2,2	-3° Neg.	MATB	1	222.096.12M

Dado Grooving



230.5

CMT designed a new Dado Precision Set with the following features:

- New Setting Points for chippers alignment.
- For flat bottom grooves & virtually splinter-free cuts in solid wood, laminates & melamines, veneer plywood.
- Includes shims (plastic & magnetic) and plastic "lock spacers" set for micro-thin adjustability.
- Orange Shield Coating protect from heat, gumming and corrosion.

★★★★★
PERFORMANCE

WOOD

NOT FOR EU

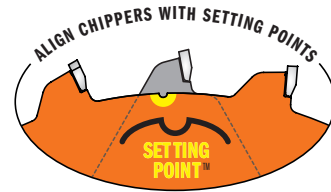

! Always use both outside blades. Never use the chippers by themselves, or with only one outside blade. Securely fasten CMT Dado on machine using manufacturer's recommended dado arbor nut.

MATERIALS



MACHINES

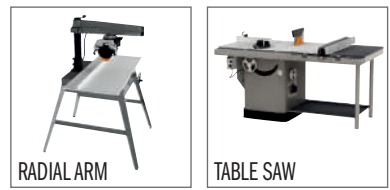

230.524.08 SET INCLUDES:

- A - Left Outside Blade (qty: 1)
- B - Right Outside Blade (qty: 1)
- C - Chippers 1/8" (qty: 4)
- D - Spacers 1/16" (qty: 2)
- E - Shims 0.004" (qty: 5)
- F - Shim 0.008" (qty: 1)
- G - Magnetic Shim 0.012" (qty: 1)
- H - Magnetic Shim 0.020" (qty: 1)

SPARE PART SET:
299.000.09

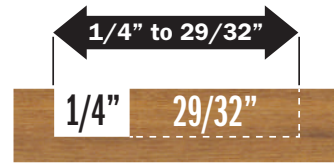
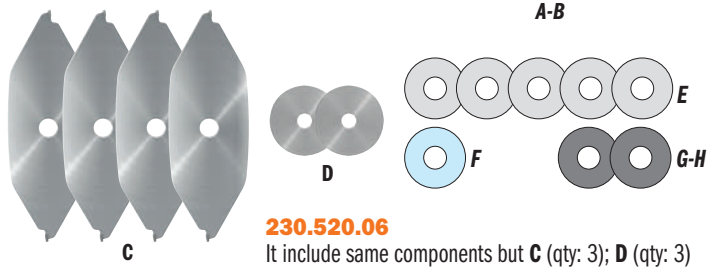

Download instructions sheets from our website

Nominal Widths	1/4"	5/16"	11/32"	3/8"	13/32"	7/16"	15/32"	1/2"	17/32"	9/16"	19/32"	5/8"	21/32"	11/16"	23/32"	3/4"	25/32"	13/16"	27/32"	7/8"	29/32"	
Left Blade	●	●	●	●	●	●	●	●	●	●	●	●	●	●	●	●	●	●	●	●	●	●
Right Blade	●	●	●	●	●	●	●	●	●	●	●	●	●	●	●	●	●	●	●	●	●	●
Chipper 1/8"	0	0	0	1	1	1	2	2	2	2	3	3	3	3	4	4	4	4	4	4	4	4
Spacer 1/16"	0	1	1	0	0	1	1	0	0	1	1	0	0	1	1	0	0	1	1	2	2	2
Shim 0.004"	1	1	0	0	1	0	1	0	0	0	0	0	0	0	0	1	0	1	0	1	0	1
Shim 0.008"	0	0	1	1	0	1	0	1	1	1	1	1	1	1	1	1	0	1	0	1	0	1
Mag. Shim 0.012"	0	0	1	0	1	0	1	0	1	0	1	0	1	0	1	1	1	1	1	1	1	1
Mag. Shim 0.020"	0	0	1	0	1	0	1	0	1	0	1	0	1	0	1	0	1	0	1	0	1	0

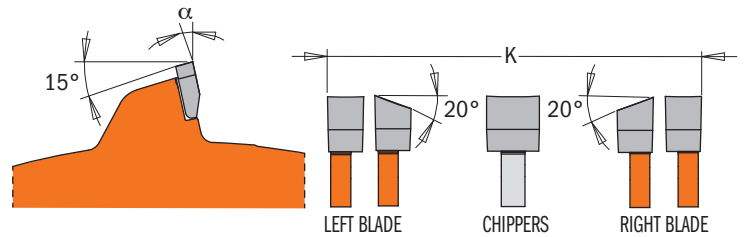
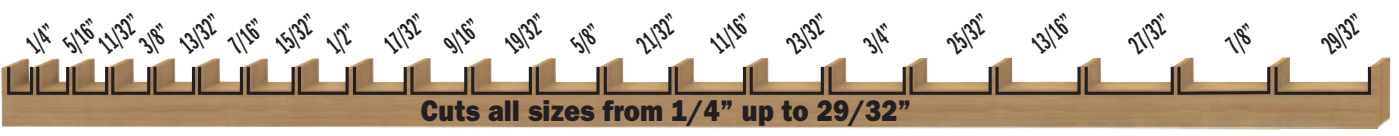

D mm	B mm	Z	α	β	Box	ORDER NO.
152	15,87	20	-12° Neg.	FLAT+ATB	3	230.520.06
203	15,87	24	-12° Neg.	FLAT+ATB	3	230.524.08



230.312

INTERNATIONAL PATENT PENDING

CMT is proud to introduce a brand new Locked Dado Pro Set unlike any other! This is the very first Dado ever deemed UNI EN847 compliant. This means that while the Dado is rotating, the assembled elements will never come into contact with each other! This is possible thanks to unique blade body design and 'never before seen' special "lock spacers".

FEATURES:

- For flat bottom grooves & virtually splinter-free cuts in solid wood, laminates & melamines, veneer plywood.
- Includes shims (plastic & magnetic) and plastic "lock spacers" set for micro-thin adjustability.
- Compatible with most radial arm saws and stationary table saws, including SAWSTOP®.
- Easy pre-assembly out of machine. Once stacked, no alignment necessary.
- Cutting teeth/assembled elements never come in contact each other, even when brake safety system kicks in.



WOOD



First ever DADO in compliance with



Always use both outside blades. Never use the chippers by themselves, or with only one outside blade. Securely fasten CMT Dado on machine using manufacturer's recommended dado arbor nut.

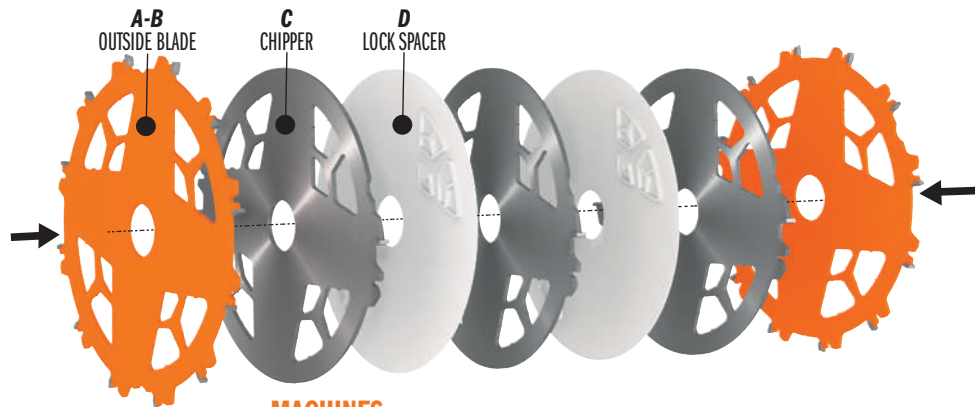

MATERIALS



MACHINES



Sturdy reusable carrying case

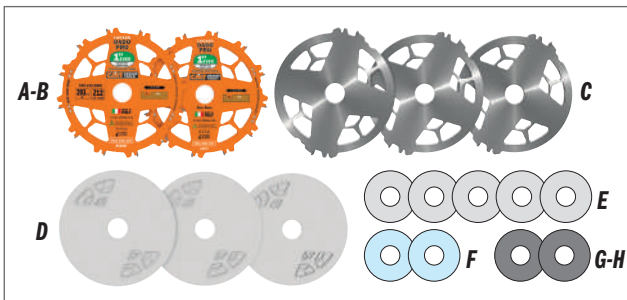

SET INCLUDES:

- A - Left Outside Blade 203mm (qty: 1)
- B - Right Outside Blade 203mm (qty: 1)
- C - Chippers 3.14mm (qty: 3)
- D - Lock Spacers 1.6mm (qty: 3)
- E - Shim 0.1mm (qty: 5)
- F - Shim 0.2mm (qty: 2)
- G - Magnetic Shim 0.3mm (qty: 1)
- H - Magnetic Shim 0.5mm (qty: 1)

SPARE PART SET



INSTRUCTIONS ON FRONT & BACK OF INSERT MUST BE USED TOGETHER



Download instructions sheets from our website



Cuts all sizes from 6mm up to 20mm

Nominal Widths	6mm	7mm	8mm	9mm	10mm	11mm	12mm	13mm	14mm	15mm	16mm	17mm	18mm	19mm	20mm
Left Blade	•	•	•	•	•	•	•	•	•	•	•	•	•	•	•
Right Blade	•	•	•	•	•	•	•	•	•	•	•	•	•	•	•
Chipper 3.14mm	0	0	0	0	1	1	1	2	2	2	2	3	3	3	3
Lock Spacer 1.6mm	0	0	1	1	0	1	1	0	1	1	2	0	1	2	2
Shim 0.1mm	0	0	0	2	1	0	0	0	1	1	0	4	0	0	2
Shim 0.2mm	0	1	2	2	1	1	2	1	0	1	1	2	1	2	2
Mag. Shim 0.3mm	0	1	0	1	0	0	1	0	0	1	1	1	1	0	1
Mag. Shim 0.5mm	0	1	0	1	1	0	1	1	0	1	0	1	1	0	1

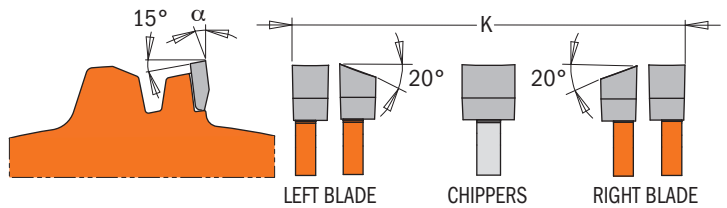

D mm	B mm	Z	α	β		ORDER NO.
203	15,87	12	-12° Neg.	FLAT+ATB	3	230.312.08
203	30	12	-12° Neg.	FLAT+ATB	3	230.312.08M

Spare parts: 299.000.08 Dado Pro Shim Set 230.312.08M
299.000.09 Dado Pro Shim Set 230.312.08



WOOD

240 INDUSTRIAL

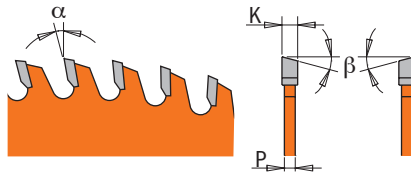

MACHINES



TOUPIE



CHUCK CNC

Blade diameter compatibility is contingent on machine type.

SUITABLE FOR THESE CNC CHUCKS:



183.410.30



183.420.30

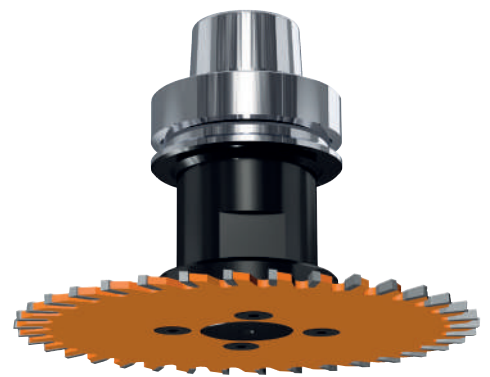

APPLICATIONS



GROOVING



CROSS

MATERIALS



WOOD



PLYWOOD



MELAMINE

D mm	B mm	PIN HOLE	Z	K mm	P mm	α	β		ORDER NO.
150	30	4/6,5 - 12/48 45°	36	3,0	2,2	5°	5°ATB	10	240.150.030M
150	30	4/6,5 - 12/48 45°	36	4,0	3,0	5°	5°ATB	10	240.150.040M
150	30	4/6,5 - 12/48 45°	36	5,0	3,0	5°	5°ATB	10	240.150.050M
150	30	4/6,5 - 12/48 45°	36	6,0	3,0	5°	5°ATB	10	240.150.060M

240 INDUSTRIAL



WOOD

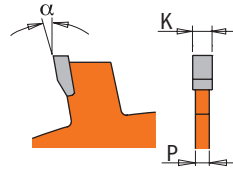

The new design allows blades stacking with different kerf thickness (see examples of stacking), subject to safety regulations in force in your area.



MACHINES



TOUPIE



CHUCK CNC

Blade diameter compatibility is contingent on machine type.

APPLICATIONS



GROOVING



GROOVING/STACKING

MATERIALS



WOOD



PLYWOOD



MELAMINE

D mm	B mm	PIN HOLE 	Z	K mm	P mm	α	β		ORDER NO.
150	30	-	12	2,0	1,4	15°	FLAT	10	240.020.06M
150	35	-	12	2,0	1,4	15°	FLAT	10	240.020.06R
150	30	-	12	3,0	2,0	15°	FLAT	10	240.030.06M
150	35	-	12	3,0	2,0	15°	FLAT	10	240.030.06R
150	30	-	12	4,0	3,0	15°	FLAT	10	240.040.06M
150	35	-	12	4,0	3,0	15°	FLAT	10	240.040.06R
150	30	-	12	5,0	3,0	15°	FLAT	10	240.050.06M
150	35	-	12	5,0	3,0	15°	FLAT	10	240.050.06R
150	30	-	12	6,0	3,0	15°	FLAT	10	240.060.06M
150	35	-	12	6,0	3,0	15°	FLAT	10	240.060.06R
180	30	-	18	3,0	2,0	15°	FLAT	10	240.030.07M
180	35	-	18	3,0	2,0	15°	FLAT	10	240.030.07R
180	30	-	18	4,0	3,0	15°	FLAT	10	240.040.07M
180	35	-	18	4,0	3,0	15°	FLAT	10	240.040.07R
180	30	-	18	5,0	3,0	15°	FLAT	10	240.050.07M
180	35	-	18	5,0	3,0	15°	FLAT	10	240.050.07R
180	30	-	18	6,0	3,0	15°	FLAT	10	240.060.07M
180	35	-	18	6,0	3,0	15°	FLAT	10	240.060.07R

Grooving System

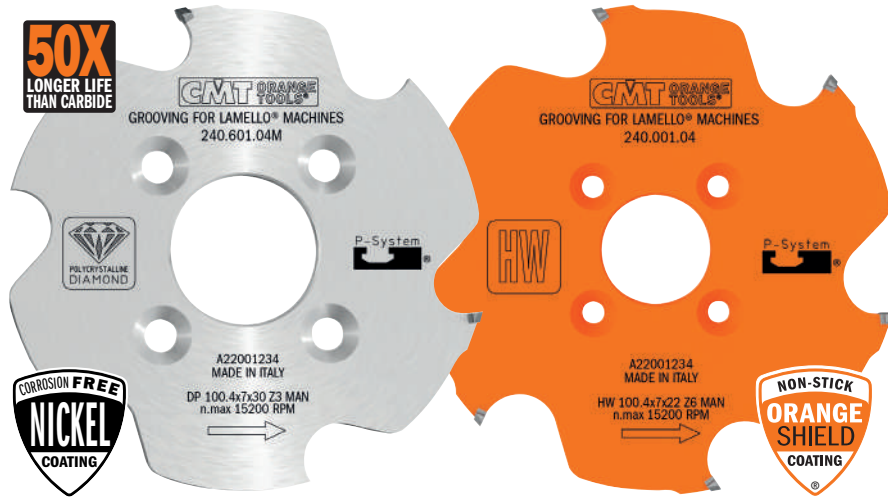

240



WOOD

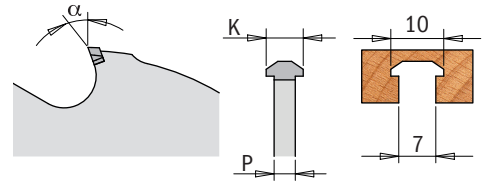

MACHINES



APPLICATIONS



MATERIALS

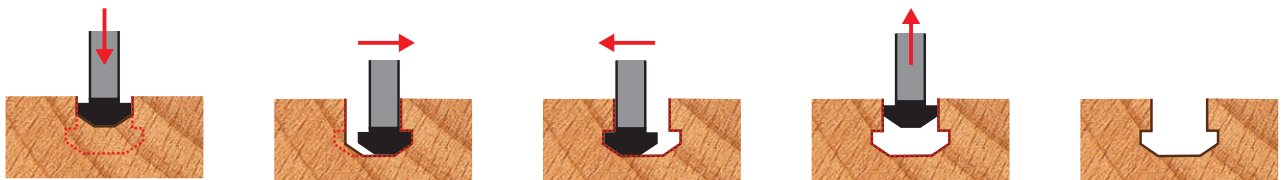
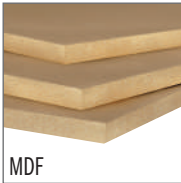

240 XTREME



D mm	B mm	TEETH MATERIAL	MACHINE	PIN HOLE	Z	K mm	P mm	α	β	COATING TYPE		ORDER NO.
100,4	22	DP	LAMELLO® ZETA P®	4/4,5 - 9,5/36	3	7	4	20°	TCG	NICKEL	1	240.601.04
100,4	30	DP	CNC	4/6,6 - 12/48	3	7	4	20°	TCG	NICKEL	1	240.601.04M

240 INDUSTRIAL



D mm	B mm	TEETH MATERIAL	MACHINE	PIN HOLE	Z	K mm	P mm	α	β	COATING TYPE		ORDER NO.
100,4	22	HW	LAMELLO® ZETA P®	4/4,5 - 9,5/36	6	7	4	20°	TCG	ORANGE SHIELD	10	240.001.04



240-241 INDUSTRIAL



WOOD

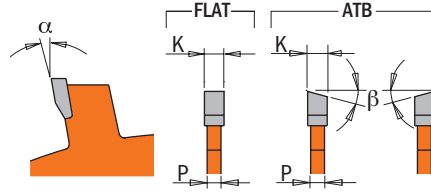

MACHINES



APPLICATIONS

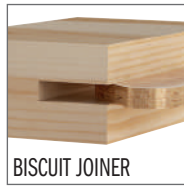

MATERIALS

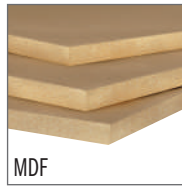

D mm	B mm	PIN HOLE	Z	K mm	P mm	α	β		ORDER NO.
100	22	4/4,5 - 9,5/36	6	3,96	3,0	18°	10° ATB	10	240.006.04
100	22	4/4,5 - 9,5/36	8	3,96	3,0	15°	10° ATB	10	240.008.04
100	22	-	8	3,96	3,1-3,8	15°	FLAT	10	241.008.04 ●

● Ideal for VIRUTEX®



240.004.04 X-TREME



WOOD

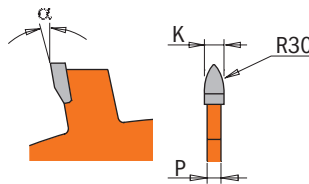

MACHINES



APPLICATIONS



MATERIALS



D mm	B mm	PIN HOLE	MACHINE	Z	K mm	P mm	α	β		ORDER NO.
100	22	4/4,5 - 9,5/36	LAMELLO®	4	8,0	6,0	18°	R30	1	240.004.04



298 ITK⁺ PLUS®

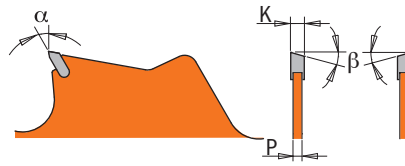

MULTI-MATERIALS



SECURED TOOTH – MORE RESISTANT TO ACCIDENTAL CONTACT

Teeth are welded deep inside blade body which significantly reduces breakage caused by accidental contact with terrain, rocks or stones, masonry work, metal parts, etc.; avoid all contact with these elements wherever possible.

HEAVY DUTY PLATE – THIN, LIGHT AND STRONG

Cut from the finest steel. Remarkably thin kerf and specifically designed perforations considerably reduce blade weight thereby reducing tool workload.

SAFETY WARNING

Circular saw blades are suitable for thinning brush and cutting small trees up to a diameter of 5 cm (2 in) in thickness. Do not attempt to cut trees with larger diameters, since the blade may catch or jerk the clearing saw forward. This may cause damage to the blade or loss of control of the power tool and result in serious injury. Use a chain saw for such work. The operator shall ensure, while working, that no persons or animals come within 15 meters (50 feet) of the tool while in operation. Inspect the work area: remove stones, rocks, pieces of metal and other solid objects which could be thrown by the cutting attachment causing damage to objects or injury to those in close proximity. To reduce the risk of blade/teeth breakage, avoid all contact with terrain, rocks or stones, masonry work, metal parts, etc.



MACHINES



BRUSH CUTTER

MATERIALS



BUSHES & SMALL TREES
(up to a diameter of Ø5 cm)



GRASS

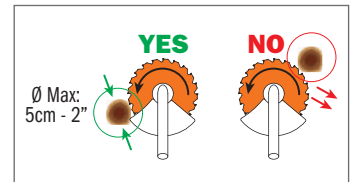

D mm	B mm	RPM max	Z	K mm	P mm	α	β		ORDER NO.
250	25,4 (+20)	12.000	20	2,0	1,4	2°	8° ATB	10	298.250.20
250	25,4 (+20)	12.000	40	2,0	1,4	2°	8° ATB	10	298.250.40



299.11

If you're looking for fast and easy saw alignment and balancing, the cut calibration and sanding disk is for you. First, mount your calibration and sanding disk in your table saw and line it up with a square for accuracy. Then, remove the calibration and sanding disk and mount your saw blade for true precise cuts. You can also use the calibration and sanding disk as a sander by simply attaching self-stick sandpaper and installing the disk in your table saw.



D mm	B mm	P mm		ORDER NO.
200	30	2,8	10	299.111.00M
250	30	2,8	10	299.112.00M

Saw Blades Stabilizers



299.10 The CMT blade stabilizer virtually eliminates rim vibration to make cleaner, straighter cuts and extend the life of your CMT saw blade. It also helps lessen noise caused by vibration during cutting.



DESCRIPTION	D mm	B mm	P mm		ORDER NO.
Stabilizer (2 pcs.) for Ø200mm	75	30	3,0	5	299.101.00M
Stabilizer (2 pcs.) for Ø250mm	125	30	3,0	5	299.102.00M
Stabilizer (2 pcs.) for Ø300mm	152	30	3,0	5	299.103.00M

NOTE: for use on stationary saws only. Each order includes 2 stabilizers.

Reduction Rings for Saw Blades

299

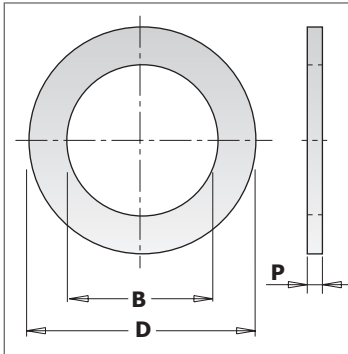

D mm	B mm	P mm		ORDER NO.	D mm	B mm	P mm		ORDER NO.
15,87	10	1,2	10	299.218.00	30	15,87	2,0	10	299.303.00
15,87	12,7	1,2	10	299.217.00	30	16	1,2	10	299.451.00
20	12,7	1,2	10	299.221.00	30	16	1,4	10	299.223.00
20	12,7	1,6	10	299.401.00	30	16	2,0	10	299.226.00
20	13	1,6	10	299.402.00	30	18	1,4	10	299.232.00
20	15	1,6	10	299.403.00	30	19,05	1,4	10	299.241.00
20	15,87	1,4	10	299.243.00	30	19,05	2,0	10	299.305.00
20	16	1,0	10	299.351.00	30	20	1,2	10	299.452.00
20	16	1,2	10	299.222.00	30	20	1,4	10	299.224.00
20	16	1,6	10	299.404.00	30	20	2,0	10	299.227.00
20	18	1,4	10	299.236.00	30	22	1,4	10	299.231.00
22,2	15	1,4	10	299.237.00	30	25	1,2	10	299.453.00
22,2	16	1,4	10	299.242.00	30	25	1,4	10	299.225.00
22,2	20	1,4	10	299.238.00	30	25	2,0	10	299.228.00
25	16	2,0	10	299.301.00	30	25,4	1,6	10	299.405.00
25	20	2,0	10	299.302.00	30	25,4	2,0	10	299.212.00
25,4	15,87	1,4	10	299.216.00	32	20	2,0	10	299.309.00
25,4	19,05	1,4	10	299.213.00	32	30	2,0	10	299.229.00
25,4	20	1,4	10	299.214.00	35	20	2,0	10	299.311.00
25,4	20	2,3	10	299.220.00	35	25	2,0	10	299.312.00
25,4	22	1,4	10	299.215.00	35	25,4	2,0	10	299.313.00
25,4	22,2	1,4	10	299.239.00	35	30	2,0	10	299.230.00
25,4	22,2	2,3	10	299.219.00	35	32	2,0	10	299.233.00
30	15	1,4	10	299.240.00	40	30	2,0	10	299.316.00
30	15,87	1,4	10	299.211.00					

Saw Blade Index

D mm	B mm	Z	K mm	P mm	α	β	MATERIALS APPLICATION	PERFORMANCE	ORDER NO.	PAGE
50	10	20	1,1	0,8	15°	10° ATB	WOOD	★★★	273.050.20D	37
70	20	8+8	2,8-3,6	-	12°	FLAT	WOOD	★★★★★	289.070.16H	50
80	10	36	1,6	1,0	15°	10° ATB	WOOD	★★★	273.080.36D	37
80	20	12	3,1-3,6	2,2	10°	CO+FLAT	WOOD	★★★★★	S288.080.12H	51
80	20	10+10	2,8-3,6	-	12°	FLAT	WOOD	★★★★★	289.080.20H	50
85	15	6	1,8	1,4	12°	TCG	MULTI-MATERIALS	★★★	236.085.06G	13
86	15	24	1,1	0,7	12°	5° ATB	WOOD	★★	K02403	14
100	20	10+10	2,8-3,6	-	12°	FLAT	WOOD	★★★★★	289.100.20H	50
100	20	20	3,1-4,0	2,5	5°	CO+5° ATB	WOOD	★★★★★	288.100.20H	51
100	22	4	8,0	6,0	18°	R30	WOOD	★★★★★	240.004.04	69
100	22	6	3,96	3,0	18°	10° ATB	WOOD	★★★★	240.006.04	69
100	22	8	3,96	3,0	15°	10° ATB	WOOD	★★★★	240.008.04	69
100	22	8	3,96	3,1-3,8	15°	FLAT	WOOD	★★★★	241.008.04	69
100	22	10+10	2,8-3,6	-	12°	FLAT	WOOD	★★★★★	289.100.20K	50
100	22	20	3,1-4,0	2,5	5°	CO+5° ATB	WOOD	★★★★★	288.100.20K	51
100,4	22	3	7	4	20°	TCG	WOOD	★★★★★	240.601.04	68
100,4	22	6	7	4	20°	TCG	WOOD	★★★★	240.001.04	68
100,4	30	3	7	4	20°	TCG	WOOD	★★★★★	240.601.04M	68
115	22,2 (+9,5+15,87)	-	-	-	-	-	MULTI-MATERIALS	-	286.115.01	12
115	22,2 (+9,5+15,87)	-	-	-	-	-	MULTI-MATERIALS	-	286.115.61	12
115	9,5	24	1,5	1,0	20°	10° ATB + 8° Shear	WOOD	★★★	272.115.24	31
120	20	12+12	2,8-3,6	-	12°	FLAT	WOOD	★★★★★	289.120.24H	50
120	20	18	1,8	1,2	15°	15° ATB	WOOD	★★★★	291.120.18H	26
120	20	20	3,1-3,7	2,2	5°	CONICAL	WOOD	★★★★★	238.120.20H	52
120	20	24	3,1-4,0	2,5	5°	CO+5° ATB	WOOD	★★★★★	288.120.24H	51
120	20	24	3,4-4,2	2,5	5°	CO+5° ATB	WOOD	★★★★★	288.120.24H1	51
120	20	36	1,8	1,2	-6° Neg.	TCG	NON-FERROUS	★★★★	296.120.36H	56
120	20	40	1,8	1,2	10°	15° ATB	WOOD	★★★★	292.120.40H	30
120	22	12+12	2,8-3,6	-	12°	FLAT	WOOD	★★★★★	289.120.24K	50
120	22	24	3,1-4,0	2,5	5°	CO+5° ATB	WOOD	★★★★★	288.120.24K	51
120	50	12+12	2,8-3,6	-	12°	FLAT	WOOD	★★★★★	289.120.24T	50
125	20	12+12	2,8-3,6	-	12°	FLAT	WOOD	★★★★★	289.125.24H	50
125	20	20	2,4	1,4	15°	15° ATB	WOOD	★★★★	291.125.20H	26
125	20	20	3,1-3,7	2,2	5°	CONICAL	WOOD	★★★★★	238.125.20H	52
125	20	24	3,1-4,0	2,5	5°	CO+5° ATB	WOOD	★★★★★	288.125.24H	51
125	20	24	3,4-4,2	2,5	5°	CO+5° ATB	WOOD	★★★★★	288.125.24H1	51
125	20	24	4,3-5,5	3,2	10°	CO+FLAT	WOOD	★★★★★	288.125.24H2	51
125	20	36	2,4	1,4	15°	15° ATB	WOOD	★★★★	292.125.36H	30
125	22	12+12	2,8-3,6	-	12°	FLAT	WOOD	★★★★★	289.125.24K	50
125	22	24	3,1-4,0	2,5	5°	CO+5° ATB	WOOD	★★★★★	288.125.24K	51
125	45	24	4,3-5,5	3,2	10°	CO+FLAT	WOOD	★★★★★	288.125.24Q	51
125	22,2	7	2,0	1,4	5°	TCG	MULTI-MATERIALS	★★★	236.125.07	13
125	22,2 (+20+15,87)	-	-	-	-	-	MULTI-MATERIALS	-	286.125.01	12
125	22,2 (+20+15,87)	-	-	-	-	-	MULTI-MATERIALS	-	286.125.61	12
130	20	20	2,4	1,4	15°	15° ATB	WOOD	★★★★	291.130.20H	26
130	20	36	2,4	1,4	15°	15° ATB	WOOD	★★★★	292.130.36H	30
136	10	30	1,5	1,2	0°	8° FWF	METAL & STEEL	★★★★	226.030.05	61
136	20	18	1,5	1,0	15°	15° ATB	WOOD	★★	K13618H-X10	14
136	20	30	1,5	1,2	0°	8° FWF	METAL & STEEL	★★★★	226.030.05H	61
136	20 (+10)	18	1,5	1,0	20°	10° ATB + 8° Shear	WOOD	★★★	271.136.18H	27
136	20 (+10)	36	1,5	1,0	18°	10° ATB + 8° Shear	WOOD	★★★	272.136.36H	31
136	20 (+10)	56	1,5	1,2	0°	8° FWF	METAL & STEEL	★★★★	226.136.56H	60
140	20	20	2,4	1,4	15°	15° ATB	WOOD	★★★★	291.140.20H	26
140	20	24	1,8	1,2	15°	15° ATB + 8° Shear	WOOD	★★★	271.140.24H	27
140	20	36	2,4	1,4	15°	15° ATB	WOOD	★★★★	292.140.36H	30
140	20	42	1,8	1,2	5°	15° ATB + 8° Shear	WOOD	★★★	272.140.42H	31
140	20	48	1,8	1,2	-6° Neg.	TCG	NON-FERROUS	★★★	276.140.48H	57

D mm	B mm	Z	K mm	P mm	α	β	MATERIALS APPLICATION	PERFORMANCE	ORDER NO.	PAGE
150	20	12	2,4	1,4	20°	10° ATB	WOOD	★★★★	290.150.12H	22
150	20	32	1,6	1,2	0°	8° FWF	METAL & STEEL	★★★★	226.032.06H	61
150	20	40	2,4	1,4	15°	15° ATB	WOOD	★★★★	292.150.40H	30
150	20	60	1,6	1,2	0°	8° FWF	METAL & STEEL	★★★★	226.150.60H	60
150	30	12	2,0	1,4	15°	FLAT	WOOD	★★★★	240.020.06M	67
150	30	12	3,0	2,0	15°	FLAT	WOOD	★★★★	240.030.06M	67
150	30	12	4,0	3,0	15°	FLAT	WOOD	★★★★	240.040.06M	67
150	30	12	5,0	3,0	15°	FLAT	WOOD	★★★★	240.050.06M	67
150	30	12	6,0	3,0	15°	FLAT	WOOD	★★★★	240.060.06M	67
150	30	36	3,0	2,2	5°	5° ATB	WOOD	★★★★	240.150.030M	66
150	30	36	4,0	3,0	5°	5° ATB	WOOD	★★★★	240.150.040M	66
150	30	36	5,0	3,0	5°	5° ATB	WOOD	★★★★	240.150.050M	66
150	30	36	6,0	3,0	5°	5° ATB	WOOD	★★★★	240.150.060M	66
150	30	48	3,2	2,2	5°	15° ATB	WOOD	★★★★	285.048.06M	30
150	35	12	2,0	1,4	15°	FLAT	WOOD	★★★★	240.020.06R	67
150	35	12	3,0	2,0	15°	FLAT	WOOD	★★★★	240.030.06R	67
150	35	12	4,0	3,0	15°	FLAT	WOOD	★★★★	240.040.06R	67
150	35	12	5,0	3,0	15°	FLAT	WOOD	★★★★	240.050.06R	67
150	35	12	6,0	3,0	15°	FLAT	WOOD	★★★★	240.060.06R	67
150	45	36	4,3-5,5	3,2	10°	CO+FLAT	WOOD	★★★★★	288.150.36Q	51
150	20 (+16)	24	2,4	1,4	15°	15° ATB	WOOD	★★★★	291.150.24H	26
150	20 (+16)	24	1,5	1,0	18°	10° ATB + 8° Shear	WOOD	★★★	271.150.24H	27
150	20 (+16)	40	1,5	1,0	16°	10° ATB + 8° Shear	WOOD	★★★	272.150.40H	31
152	15,87	20	-	-	-12° Neg.	FLAT+ATB	WOOD	★★★★★	230.520.06	64
160	16	12	2,2	1,6	20°	10° ATB	WOOD	★★★★	290.160.12E	22
160	20	4	2,4	1,8	12°	TCG	MULTI-MATERIALS	★★★	236.160.04H	13
160	20	10	2,4	1,8	5°	TCG	MULTI-MATERIALS	★★★	236.160.10H	13
160	20	10	2,4	1,8	5°	TCG	MULTI-MATERIALS	★★	K160-10HD	15
160	20	20	2,2	1,6	10°	HR	MULTI-MATERIALS	★★★★★	235.160.20H	53
160	20	24	2,3	1,2	5°	5° ATB	WOOD & NAILS	★★★★★	286.760.24H	11
160	20	24	2,2	1,6	15°	15° ATB	WOOD	★★★★	291.160.24H	26
160	20	24	2,2	1,6	5°	TCG	NON-FERROUS	★★★★	284.160.24H	54
160	20	24	2,2	1,4	15°	15° ATB	WOOD	★★	K16024H	14
160	20	24	2,2	1,4	15°	15° ATB	WOOD	★★	K16024H-X10	14
160	20	28	2,2	1,6	15°	10° ATB	WOOD	★★★★	285.160.28H	26
160	20	30	2,0	1,6	0°	8° FWF	METAL & STEEL	★★★★	226.030.06H	61
160	20	34	2,6	1,8	10°	HDF	WOOD	★★★★	287.034.06H	35
160	20	40	2,2	1,6	10°	15° ATB	WOOD	★★★★	292.160.40H	30
160	20	40	2,2	1,6	-6° Neg.	TCG	NON-FERROUS	★★★★	296.160.40H	56
160	20	40	1,8	1,4	0°	TCG	METAL & STEEL	★★★★	226.540.06H	62
160	20	40	2,2	1,4	10°	15° ATB	WOOD	★★	K16040H	14
160	20	40	2,2	1,4	10°	15° ATB	WOOD	★★	K16040H-X10	14
160	20	48	2,2	1,6	5°	15° ATB	WOOD	★★★★	285.160.48H	30
160	20	48	2,2	1,6	5°	12° ATB	WOOD	★★★★★	285.760.48H	32
160	20	48	1,8	1,2	5°	12° ATB	WOOD	★★★★★	285.761.48H	32
160	20	48	2,2	1,6	4°	TCG	WOOD	★★★★★	281.760.48H	42
160	20	48	2,2	1,6	5°	TCG	WOOD	★★★★	281.160.48H	47
160	20	48	2,2	1,6	0°	MTCG	MULTI-MATERIALS	★★★★★	223.048.06H	63
160	20	52	1,8	1,2	-5° Neg.	TCG	WOOD	★★★★★	281.761.52H	46
160	20	52	2,2	1,8	-5° Neg.	TCG	NON-FERROUS	★★★★★	296.760.52H	55
160	20	52	1,8	1,2	-5° Neg.	TCG	NON-FERROUS	★★★★★	296.761.52H	55
160	20	56	2,2	1,6	15°	15° ATB	WOOD	★★★★	292.160.56H	36
160	20	56	2,2	1,6	-3° Neg.	TCG	WOOD	★★★★	281.161.56H	47
160	20	56	2,2	1,6	-6° Neg.	TCG	NON-FERROUS	★★★★	296.160.56H	56
160	30	40	2,2	1,6	10°	15° ATB	WOOD	★★★★	292.160.40M	30
160	45	36	4,3-5,5	3,2	10°	CO+FLAT	WOOD	★★★★★	288.160.36Q	51
160	55	36	4,3-5,5	3,2	10°	CO+FLAT	WOOD	★★★★★	288.160.360	51

Saw Blade Index

D mm	B mm	Z	K mm	P mm	α	β	MATERIALS APPLICATION	PERFORMANCE	ORDER NO.	PAGE
160	20 (+16)	60	2,0	1,6	0°	8° FWF	METAL & STEEL	★★★★	226.160.60H	60
160	20 (+16)	12	2,2	1,6	20°	10° ATB	WOOD	★★★★	290.160.12H	22
160	20 (+16)	24	1,8	1,2	18°	10° ATB + 8° Shear	WOOD	★★★	271.160.24H	27
160	20 (+16)	40	1,8	1,2	16°	10° ATB + 8° Shear	WOOD	★★★	272.160.40H	31
160	20 (+16)	48	1,8	1,2	-6° Neg.	TCG	NON-FERROUS	★★★	276.160.48H	57
160	20 (+16)	56	1,8	1,2	12°	10° ATB + 8° Shear	WOOD	★★★	273.160.56H	37
160	20 (VIRUTEX®)	40	2,2	1,6	10°	TCG	WOOD	★★★★	281.160.40H	47
160	30 (+16)	24	2,2	1,6	15°	15° ATB	WOOD	★★★★	291.160.24M	26
165	20	24	2,3	1,2	5°	5° ATB	WOOD & NAILS	★★★★★	286.765.24H	11
165	20	24	2,2	1,6	15°	15° ATB	WOOD	★★★★	291.165.24H	26
165	20	24	1,7	1,1	15°	15° ATB	WOOD	★★	K16524H	14
165	20	24	1,7	1,1	15°	15° ATB	WOOD	★★	K16524H-X10	14
165	20	36	1,6	1,2	0°	8° FWF	METAL & STEEL	★★★★	226.036.06H	61
165	20	40	2,2	1,6	10°	15° ATB	WOOD	★★★★	292.165.40H	30
165	20	40	2,2	1,6	-6° Neg.	TCG	NON-FERROUS	★★★★	296.165.40H	56
165	20	40	1,7	1,1	15°	15° ATB	WOOD	★★	K16540H-X10	14
165	20	52	1,8	1,2	-5° Neg.	TCG	WOOD	★★★★★	281.766.52H	46
165	20	56	2,2	1,6	15°	15° ATB	WOOD	★★★★	292.165.56H	36
165	20	56	2,2	1,6	-3° Neg.	TCG	WOOD	★★★★	281.166.56H	47
165	20	56	2,2	1,6	-6° Neg.	TCG	NON-FERROUS	★★★★	296.165.56H	56
165	20	60	1,6	1,2	0°	8° FWF	METAL & STEEL	★★★★	226.165.60H	60
165	30	24	2,6	1,6	15°	15° ATB	WOOD	★★★★	291.165.24M	26
165	30	24	1,7	1,1	18°	10° ATB + 8° Shear	WOOD	★★★	271.165.24M	27
165	30	36	1,6	1,2	0°	8° FWF	METAL & STEEL	★★★★	226.036.06M	61
165	30	40	2,6	1,6	10°	15° ATB	WOOD	★★★★	292.165.40M	30
165	15,87	36	1,6	1,2	0°	8° FWF	METAL & STEEL	★★★★	226.036.06	61
165	20 (+15,87)	4	1,8	1,4	12°	TCG	MULTI-MATERIALS	★★★	236.165.04H	13
165	20 (+15,87)	10	1,8	1,4	5°	TCG	MULTI-MATERIALS	★★★	236.165.10H	13
165	20 (+15,87)	24	1,7	1,1	18°	10° ATB + 8° Shear	WOOD	★★★	271.165.24H	27
165	20 (+15,87)	36	1,7	1,1	20°	10° ATB + 8° Shear	WOOD	★★★	272.165.36H	31
165	20 (+15,87)	56	1,6	1,0	12°	15° ATB + 8° Shear	WOOD	★★★	273.165.56H	37
165	20 (+15,87)	56	1,8	1,2	-6° Neg.	TCG	NON-FERROUS	★★★	276.165.56H	57
168	20	10	1,8	1,2	5°	TCG	MULTI-MATERIALS	★★★	236.168.10H	13
168	20	28	1,8	1,2	15°	15° ATB + 8° Shear	WOOD	★★★	271.168.28H	27
168	20	42	1,8	1,2	10°	15° ATB + 8° Shear	WOOD	★★★	272.168.42H	31
168	20	48	1,8	1,2	5°	12° ATB	WOOD	★★★★★	285.768.48H	32
168	20	52	1,8	1,2	-5° Neg.	TCG	WOOD	★★★★★	281.768.52H	46
168	20	52	1,8	1,2	-5° Neg.	TCG	NON-FERROUS	★★★★★	296.768.52H	55
168	20	52	1,8	1,2	-5° Neg.	TCG	NON-FERROUS	★★★	276.168.52H	57
170	30	24	2,6	1,6	20°	10° ATB	WOOD	★★★★	291.170.24M	26
170	30	40	2,6	1,6	15°	15° ATB	WOOD	★★★★	292.170.40M	30
180	20	4	2,4	1,8	12°	TCG	MULTI-MATERIALS	★★★	236.180.04H	13
180	20	24	2,6	1,6	20°	10° ATB	WOOD	★★★★	291.180.24H	26
180	20	36	4,3-5,5	3,2	10°	CO+FLAT	WOOD	★★★★★	Y288.180.36H	51
180	20	40	2,6	1,6	15°	15° ATB	WOOD	★★★★	292.180.40H	30
180	20	40	2,8	2,2	-6° Neg.	TCG	NON-FERROUS	★★★★	296.180.40H	56
180	30	12	2,6	1,6	20°	10° ATB	WOOD	★★★★	290.180.12M	22
180	30	18	3,0	2,0	15°	FLAT	WOOD	★★★★	240.030.07M	67
180	30	18	4,0	3,0	15°	FLAT	WOOD	★★★★	240.040.07M	67
180	30	18	5,0	3,0	15°	FLAT	WOOD	★★★★	240.050.07M	67
180	30	18	6,0	3,0	15°	FLAT	WOOD	★★★★	240.060.07M	67
180	30	24	2,6	1,6	20°	10° ATB	WOOD	★★★★	291.180.24M	26
180	30	36	4,5-5,5	3,2	10°	CO+FLAT	WOOD	★★★★★	288.180.36M	51
180	30	40	2,6	1,6	15°	15° ATB	WOOD	★★★★	292.180.40M	30
180	30	56	3,2	2,2	5°	15° ATB	WOOD	★★★★	285.056.07M	30
180	35	18	3,0	2,0	15°	FLAT	WOOD	★★★★	240.030.07R	67
180	35	18	4,0	3,0	15°	FLAT	WOOD	★★★★	240.040.07R	67

D mm	B mm	Z	K mm	P mm	α	β	MATERIALS APPLICATION	PERFORMANCE	ORDER NO.	PAGE
180	35	18	5,0	3,0	15°	FLAT	WOOD	★★★★	240.050.07R	67
180	35	18	6,0	3,0	15°	FLAT	WOOD	★★★★	240.060.07R	67
180	40	21+3	2,5	1,8	18°	FLAT	WOOD	★★★★	280.021.07S	16
180	45	36	4,3-5,5	3,2	8°	CO+5° ATB	WOOD	★★★★★	288.180.36Q2	51
180	45	36	4,7-6,0	3,5	10°	CO+FLAT	WOOD	★★★★★	288.180.36Q	51
180	50	44	4,3-5,5	3,2	10°	CO+FLAT	WOOD	★★★★★	288.180.44T	51
180	55	36	5,0-6,2	3,5	10°	CO+FLAT	WOOD	★★★★★	288.180.360	51
184	16	24	2,6	1,6	20°	10° ATB	WOOD	★★★★	291.184.24E	26
184	16	40	2,6	1,6	15°	15° ATB	WOOD	★★★★	292.184.40E	30
184	30	24	2,6	1,6	20°	10° ATB	WOOD	★★★★	291.184.24M	26
184	30	24	1,7	1,1	20°	10° ATB + 8° Shear	WOOD	★★★	271.184.24M	27
184	30	40	2,6	1,6	15°	15° ATB	WOOD	★★★★	292.184.40M	30
184	30	40	1,7	1,1	18°	10° ATB + 8° Shear	WOOD	★★★	272.184.40M	31
184	15,87	48	2,0	1,6	0°	TCG	METAL & STEEL	★★★★	226.548.07	62
184	15,87	48	2,0	1,6	0°	8° FWF	METAL & STEEL	★★★★	226.048.07	61
184	20 (+16+15,87)	24	1,7	1,1	20°	10° ATB + 8° Shear	WOOD	★★★	271.184.24H	27
184	20 (+16+15,87)	40	1,7	1,1	18°	10° ATB + 8° Shear	WOOD	★★★	272.184.40H	31
184	20 (+16+15,87)	48	1,8	1,2	-6° Neg.	TCG	NON-FERROUS	★★★	276.184.48H	57
184	30 (+16+20)	64	2,0	1,6	0°	8° FWF	METAL & STEEL	★★★★	226.184.64M	60
190	16	24	2,6	1,6	20°	10° ATB	WOOD	★★★★	291.190.24E	26
190	20	12	2,6	1,6	20°	10° ATB	WOOD	★★★★	290.190.12H	22
190	20	24	2,6	1,6	20°	10° ATB	WOOD	★★★★	291.190.24H	26
190	30	4	2,4	1,8	12°	TCG	MULTI-MATERIALS	★★★	236.190.04M	13
190	30	12	2,4	1,8	12°	TCG	MULTI-MATERIALS	★★★	236.190.12M	13
190	30	24	2,3	1,2	5°	5° ATB	WOOD & NAILS	★★★★★	286.790.24M	11
190	30	24	2,6	1,6	20°	10° ATB	WOOD	★★★★	291.190.24M	26
190	30	24	2,5	2,0	10°	HR	MULTI-MATERIALS	★★★★★	235.190.24M	53
190	30	24	2,2	1,4	20°	10° ATB	WOOD	★★	K19024M	14
190	30	24	2,2	1,4	20°	10° ATB	WOOD	★★	K19024M-X10	14
190	30	30	2,6	2,2	5°	TCG	NON-FERROUS	★★★★	284.190.30M	54
190	30	40	2,6	1,6	15°	15° ATB	WOOD	★★★★	292.190.40M	30
190	30	40	2,8	2,2	-6° Neg.	TCG	NON-FERROUS	★★★★	296.190.40M	56
190	30	40	2,0	1,6	0°	8° FWF	METAL & STEEL	★★★★	226.040.07M	61
190	30	48	1,8	1,4	0°	TCG	METAL & STEEL	★★★★	226.548.07M	62
190	30	54	2,6	1,8	4°	TCG	WOOD	★★★★★	281.790.54M	46
190	30	64	2,6	1,6	15°	15° ATB	WOOD	★★★★	292.190.64M	36
190	30	64	2,8	2,2	-6° Neg.	TCG	NON-FERROUS	★★★★	296.190.64M	56
190	30 (+20)	64	2,0	1,6	0°	8° FWF	METAL & STEEL	★★★★	226.190.64M	60
190	20 (+16)	40	2,6	1,6	15°	15° ATB	WOOD	★★★★	292.190.40H	30
190	20 (FESTOOL® FF)	32	2,6	1,8	10°	10° ATB	WOOD	★★★★	291.190.32FF	26
190	20 (FESTOOL® FF)	48	2,4	1,8	10°	15° ATB	WOOD	★★★★	292.190.48FF	30
190	20 (FESTOOL® FF)	48	2,4	1,8	8°	15° ATB	WOOD	★★★★★	285.790.48FF	32
190	20 (FESTOOL® FF)	54	2,6	1,8	4°	TCG	WOOD	★★★★★	281.790.54FF	42
190	20 (FESTOOL® FF)	64	2,8	2,2	-6° Neg.	TCG	NON-FERROUS	★★★★	296.190.64FF	56
190	30 (+20+16)	12	2,6	1,6	20°	10° ATB	WOOD	★★★★	290.190.12M	22
190	30 (+20+16)	24	1,7	1,1	20°	10° ATB + 8° Shear	WOOD	★★★	271.190.24M	27
190	30 (+20+16)	42	1,7	1,1	18°	10° ATB + 8° Shear	WOOD	★★★	272.190.42M	31
190	30 (+20+16)	64	1,7	1,1	15°	10° ATB + 8° Shear	WOOD	★★★	273.190.64M	37
190	30 (+20+16)	64	1,8	1,2	-6° Neg.	TCG	NON-FERROUS	★★★	276.190.64M	57
200	20	36	4,4-5,3	3,2	10°	CO+FLAT	WOOD	★★★★★	288.200.36H	51
200	30	24	2,8	1,8	20°	10° ATB	WOOD	★★★★	290.200.24M	22
200	30	36	2,8	1,8	15°	15° ATB	WOOD	★★★★	291.200.36M	26
200	30	36	3,2	2,2	15°	10° ATB	WOOD	★★★★	285.036.08M	26
200	30	36	1,8	1,2	15°	10° ATB + 8° Shear	WOOD	★★★	271.200.36M	27
200	30	48	2,8	1,8	15°	15° ATB	WOOD	★★★★	292.200.48M	30
200	30	48	3,2	2,2	15°	15° ATB	WOOD	★★★★	285.048.08M	30
200	30	48	1,8	1,2	15°	10° ATB + 8° Shear	WOOD	★★★	272.200.48M	31

Saw Blade Index

D mm	B mm	Z	K mm	P mm	α	β	MATERIALS APPLICATION	PERFORMANCE	ORDER NO.	PAGE
200	30	48	2,8	2,2	-6° Neg.	TCG	NON-FERROUS	★★★★★	296.200.48M	56
200	30	64	3,2	2,2	5°	15° ATB	WOOD	★★★★★	285.064.08M	36
200	30	64	3,2	2,2	10°	TCG	WOOD	★★★★★	281.064.08M	47
200	32	0	1,8	-	-	Not Sharpened	METAL & STEEL	-	227.200P	59
200	32	160	1,8	-	-	BW	METAL & STEEL	-	227.200.160P	59
200	40	21+3	2,5	1,8	18°	FLAT	WOOD	★★★★★	280.021.08S	16
200	45	36	4,7-6,0	3,5	10°	CO+FLAT	WOOD	★★★★★	288.200.36Q	51
200	45	36	4,3-5,5	3,2	10°	CO+FLAT	WOOD	★★★★★	Y288.200.36Q2	51
200	65	36	4,4-5,3	3,2	10°	CO+FLAT	WOOD	★★★★★	288.200.36J	51
203	30	12	-	-	-12° Neg.	FLAT+ATB	WOOD	★★★★★	230.312.08M	65
203	15,87	12	-	-	-12° Neg.	FLAT+ATB	WOOD	★★★★★	230.312.08	65
203	15,87	24	-	-	-12° Neg.	FLAT+ATB	WOOD	★★★★★	230.524.08	64
203	15,87	48	2,2	1,8	0°	8° FWF	METAL & STEEL	★★★★★	226.048.08	61
210	25	36	2,8	1,8	15°	15° ATB	WOOD	★★★★★	291.210.36L	26
210	25	48	2,8	1,8	15°	15° ATB	WOOD	★★★★★	292.210.48L	30
210	30	12	2,4	1,8	12°	TCG	MULTI-MATERIALS	★★★	236.210.12M	13
210	30	24	2,8	1,8	20°	10° ATB	WOOD	★★★★★	290.210.24M	22
210	30	36	2,8	1,8	15°	15° ATB	WOOD	★★★★★	291.210.36M	26
210	30	48	2,8	1,8	15°	15° ATB	WOOD	★★★★★	292.210.48M	30
210	30	48	2,8	2,2	-6° Neg.	TCG	NON-FERROUS	★★★★★	296.210.48M	56
210	30	48	2,2	1,8	0°	8° FWF	METAL & STEEL	★★★★★	226.048.08M	61
210	30	60	2,6	1,6	-3° Neg.	TCG	WOOD	★★★★★	281.810.60M	46
210	30	64	2,8	1,8	15°	15° ATB	WOOD	★★★★★	292.210.64M	36
210	30	64	2,8	2,2	-6° Neg.	TCG	NON-FERROUS	★★★★★	296.210.64M	56
210	30	64	2,2	1,8	0°	8° FWF	METAL & STEEL	★★★★★	226.210.64M	60
210	30 (+25)	24	1,8	1,2	20°	10° ATB + 8° Shear	WOOD	★★★	271.210.24M	27
210	30 (+25)	36	1,8	1,2	15°	10° ATB + 8° Shear	WOOD	★★★	271.210.36M	27
210	30 (+25)	48	1,8	1,2	15°	10° ATB + 8° Shear	WOOD	★★★	272.210.48M	31
210	30 (+25)	64	1,8	1,2	-6° Neg.	TCG	NON-FERROUS	★★★	276.210.64M	57
215	50	42	4,3-5,5	3,2	8°	CO+FLAT	WOOD	★★★★★	288.215.42T	51
216	30	14	2,4	1,8	12°	TCG	MULTI-MATERIALS	★★★	236.216.14M	13
216	30	24	2,8	1,8	-5° Neg.	15° ATB	WOOD	★★★★★	290.216.24M	22
216	30	24	2,4	1,6	-5° Neg.	15° ATB	WOOD	★★	K21624M	14
216	30	24	2,4	1,6	-5° Neg.	15° ATB	WOOD	★★	K21624M-X10	14
216	30	30	2,5	2,0	10°	HR	MULTI-MATERIALS	★★★★★	235.216.30M	53
216	30	36	1,8	1,2	-5° Neg.	10° ATB + 8° Shear	WOOD	★★★	271.216.36M	27
216	30	40	2,6	2,2	5°	TCG	NON-FERROUS	★★★★★	284.216.40M	54
216	30	48	2,8	1,8	-5° Neg.	15° ATB	WOOD	★★★★★	291.216.48M	26
216	30	48	2,3	1,6	-5° Neg.	15° ATB	WOOD	★★★★★	285.816.48M	28
216	30	48	1,8	1,2	-5° Neg.	10° ATB + 8° Shear	WOOD	★★★	272.216.48M	31
216	30	48	2,2	1,8	0°	8° FWF	METAL & STEEL	★★★★★	226.047.09M	61
216	30	48	2,4	1,6	-5° Neg.	15° ATB	WOOD	★★	K21648M	14
216	30	48	2,4	1,6	-5° Neg.	15° ATB	WOOD	★★	K21648M-X10	14
216	30	56	1,8	1,4	0°	TCG	METAL & STEEL	★★★★★	226.556.09M	62
216	30	60	2,3	1,6	-5° Neg.	15° ATB	WOOD	★★★★★	285.816.60M	32
216	30	64	2,8	1,8	-5° Neg.	15° ATB	WOOD	★★★★★	292.216.64M	30
216	30	64	1,8	1,2	-5° Neg.	10° ATB + 8° Shear	WOOD	★★★	273.216.64M	37
216	30	64	2,6	1,6	-3° Neg.	TCG	WOOD	★★★★★	281.816.64M	46
216	30	64	2,3	1,6	0°	TCG	NON-FERROUS	★★★★★	297.816.64M	55
216	30	64	2,8	2,2	-6° Neg.	TCG	NON-FERROUS	★★★★★	297.064.09M	56
216	30	64	2,2	1,6	-6° Neg.	TCG	NON-FERROUS	★★★	276.216.64M	57
216	30	64	2,2	1,8	0°	8° FWF	METAL & STEEL	★★★★★	226.216.64M	60
216	30	80	2,8	1,8	-5° Neg.	15° ATB	WOOD	★★★★★	292.216.80M	36
216	30	80	2,8	2,2	-6° Neg.	TCG	NON-FERROUS	★★★★★	297.080.09M	56
220	30	24	2,8	1,8	20°	10° ATB	WOOD	★★★★★	290.220.24M	22
220	30	36	2,8	1,8	15°	15° ATB	WOOD	★★★★★	291.220.36M	26
220	30	42	3,2	2,2	-6° Neg.	HDF	WOOD	★★★★★	287.043.09M	34

D mm	B mm	Z	K mm	P mm	α	β	MATERIALS APPLICATION	PERFORMANCE	ORDER NO.	PAGE
220	30	42	3,2	2,2	10°	HDF	WOOD	★★★★	287.042.09M	35
220	30	48	2,8	1,8	15°	15° ATB	WOOD	★★★★	292.220.48M	30
220	30	63	3,2	2,2	-3° Neg.	FFT	WOOD	★★★★★	281.063.09M	45
220	30	64	3,2	2,2	-5° Neg.	40° Hi-ATB	WOOD	★★★★★	283.064.09M	39
220	30	64	3,2	2,2	10°	TCG	WOOD	★★★★	281.064.09M	47
225	30	36	2,8	1,8	20°	15° ATB	WOOD	★★★★	291.225.36M	26
225	30	48	2,8	1,8	10°	15° ATB	WOOD	★★★★	292.225.48M	30
225	30	64	2,6	1,8	4°	TCG	WOOD	★★★★	281.225.64M	47
225	30	64	2,8	2,2	-6° Neg.	TCG	NON-FERROUS	★★★★	296.225.64M	56
225	32	0	1,9	-	-	Not Sharpened	METAL & STEEL	-	227.225P	59
225	32	180	1,9	-	-	BW	METAL & STEEL	-	227.225.180P	59
230	30	4	2,4	1,8	12°	TCG	MULTI-MATERIALS	★★★	236.230.04M	13
230	30	24	2,8	1,8	20°	10° ATB	WOOD	★★★★	290.230.24M	22
230	30	36	2,8	1,8	15°	15° ATB	WOOD	★★★★	291.230.36M	26
230	30	48	2,8	1,8	15°	15° ATB	WOOD	★★★★	292.230.48M	30
230	30	48	2,8	2,2	-6° Neg.	TCG	NON-FERROUS	★★★★	296.230.48M	56
230	30	64	2,8	1,8	15°	15° ATB	WOOD	★★★★	292.230.64M	36
230	22,2	-	-	-	-	-	MULTI-MATERIALS	-	286.230.01	12
235	25	24	2,8	1,8	20°	10° ATB	WOOD	★★★★	290.235.24L	22
235	25	36	2,8	1,8	15°	15° ATB	WOOD	★★★★	291.235.36L	26
235	25	36	1,7	1,2	20°	1 FLAT+2/15° ATB	WOOD	★★★	271.235.36L	27
235	25	48	2,8	1,8	15°	15° ATB	WOOD	★★★★	292.235.48L	30
235	30	36	2,8	1,8	15°	15° ATB	WOOD	★★★★	291.235.36M	26
235	30	48	2,8	1,8	15°	15° ATB	WOOD	★★★★	292.235.48M	30
235	30	48	2,8	2,2	-6° Neg.	TCG	NON-FERROUS	★★★★	296.235.48M	56
235	30	48	2,2	1,8	0°	8° FWF	METAL & STEEL	★★★★	226.048.09M	61
235	30 (+25)	24	2,8	1,8	20°	10° ATB	WOOD	★★★★	290.235.24M	22
235	30 (+25)	36	2,4	1,6	18°	10° ATB + 8° Shear	WOOD	★★★	271.235.36M	27
235	30 (+25)	48	2,4	1,6	18°	10° ATB + 8° Shear	WOOD	★★★	272.235.48M	31
240	30	24	2,8	1,8	20°	10° ATB	WOOD	★★★★	290.240.24M	22
240	30	36	2,8	1,8	15°	15° ATB	WOOD	★★★★	291.240.36M	26
240	30	48	2,8	1,8	15°	15° ATB	WOOD	★★★★	292.240.48M	30
250	20	40	3,2	2,2	15°	10° ATB	WOOD	★★★★★	285.040.10H	25
250	30	16	2,8	1,8	15°	5° ATB	WOOD	★★★★	286.016.10M	10
250	30	16	2,4	1,8	12°	TCG	MULTI-MATERIALS	★★★	236.250.16M	13
250	30	24	3,2	2,2	10°	FLAT	WOOD	★★★★★	285.624.10M	20
250	30	24	2,8	1,8	20°	10° ATB	WOOD	★★★★	290.250.24M	22
250	30	24	2,4	1,6	20°	10° ATB + 8° Shear	WOOD	★★★	271.250.24M	23
250	30	36	2,5	2,0	10°	HR	MULTI-MATERIALS	★★★★★	235.250.36M	53
250	30	40	3,2	2,2	5°	10° ATB	WOOD	★★★★★	285.640.10M	24
250	30	40	3,2	2,2	5°	10° ATB	WOOD	★★★★★	285.040.10M	25
250	30	40	2,6	1,8	15°	10° ATB	WOOD	★★	K25040M	14
250	30	40	2,6	1,8	15°	10° ATB	WOOD	★★	K25040M-X05	14
250	30	42	2,4	1,6	18°	10° ATB + 8° Shear	WOOD	★★★	271.250.42M	27
250	30	48	3,2	2,2	15°	10° ATB	WOOD	★★★★★	285.048.10M	25
250	30	48	3,2	2,2	-6° Neg.	HDF	WOOD	★★★★	287.049.10M	34
250	30	48	3,2	2,2	10°	HDF	WOOD	★★★★	287.048.10M	35
250	30	48	3,2	2,2	10°	TCG	WOOD	★★★★★	237.048.10M	52
250	30	50	2,4	1,6	15°	FLAT + 10° ATB + 8° Shear	WOOD	★★★	272.250.50M	31
250	30	60	3,2	2,2	10°	15° ATB	WOOD	★★★★★	285.660.10M	28
250	30	60	3,2	2,2	10°	15° ATB	WOOD	★★★★★	285.060.10M	29
250	30	60	2,4	1,6	15°	10° ATB + 8° Shear	WOOD	★★★	272.250.60M	31
250	30	60	3,2	2,2	10°	TCG	WOOD	★★★★★	281.060.10M	43
250	30	60	3,2	2,2	-3° Neg.	FFT	WOOD	★★★★★	281.061.10M	45
250	30	72	2,2	1,8	0°	10° FWF	METAL & STEEL	★★★★	226.572.10M	62
250	30	72	3,2	2,5	0°	MTCG	MULTI-MATERIALS	★★★★★	223.072.10M	63
250	30	78	3,2	2,2	10°	FFT	WOOD	★★★★★	295.078.10M	44

Saw Blade Index



D mm	B mm	Z	K mm	P mm	α	β	MATERIALS APPLICATION	PERFORMANCE	ORDER NO.	PAGE
250	30	80	3,2	2,2	5°	15° ATB	WOOD	★★★★★	285.680.10M	32
250	30	80	3,2	2,2	5°	15° ATB	WOOD	★★★★★	285.080.10M	33
250	30	80	2,4	1,6	12°	10° ATB + 8° Shear	WOOD	★★★	273.250.80M	37
250	30	80	3,2	2,2	-2° Neg.	38° Hi-ATB	WOOD	★★★★★	283.680.10M	38
250	30	80	3,2	2,2	-2° Neg.	40° Hi-ATB	WOOD	★★★★★	283.080.10M	39
250	30	80	3,0	2,5	10°	20° ATB	WOOD	★★★★★	285.580.10M	40
250	30	80	3,2	2,2	15°	1° FLAT + 4° ATB	WOOD	★★★★★	274.080.10M	41
250	30	80	3,2	2,2	5°	TCG	WOOD	★★★★★	281.680.10M	42
250	30	80	3,2	2,2	10°	TCG	WOOD	★★★★★	281.080.10M	43
250	30	80	3,2	2,2	-3° Neg.	TCG	WOOD	★★★★★	281.681.10M	46
250	30	80	3,2	2,5	-6° Neg.	TCG	NON-FERROUS	★★★★★	297.080.10M	55
250	30	80	2,6	1,8	-6° Neg.	TCG	NON-FERROUS	★★★	276.250.80M	57
250	30	80	2,8	2,2	-3° Neg.	MATB	MULTI-MATERIALS	★★★★★	222.080.10M	63
250	30	20+4	3,2	2,2	18°	10° ATB	WOOD	★★★★	279.020.10M	18
250	32	0	2,0	-	-	Not Sharpened	METAL & STEEL	-	227.250P	59
250	32	80	3,2	2,5	6°	TCG	NON-FERROUS	★★★★★	284.080.10P	54
250	32	80	3,2	2,5	-6° Neg.	TCG	NON-FERROUS	★★★★★	297.080.10P	55
250	32	128	2,0	-	-	C/HZ	METAL & STEEL	-	227.250.128P	58
250	32	160	2,0	-	-	BW	METAL & STEEL	-	227.250.160P	59
250	32	200	2,0	-	-	BW	METAL & STEEL	-	227.250.200P	59
250	32	200	2,0	-	-	BW	METAL & STEEL	-	227.250.700P	59
250	35	40	3,2	2,2	15°	10° ATB	WOOD	★★★★★	285.040.10R	25
250	35	60	3,2	2,2	10°	15° ATB	WOOD	★★★★★	285.060.10R	29
250	35	80	3,2	2,2	5°	15° ATB	WOOD	★★★★★	285.080.10R	33
250	70	20+4	2,7	1,8	18°	10° ATB	WOOD	★★★★	280.020.10V	16
250	70	20+4	3,2	2,2	18°	10° ATB	WOOD	★★★★	279.020.10V	18
250	80	20+4	2,7	1,8	18°	10° ATB	WOOD	★★★★	280.020.10W	16
250	80	20+4	3,2	2,2	18°	10° ATB	WOOD	★★★★	279.020.10W	18
250	25,4 (+20)	20	2,0	1,4	2°	8° ATB	MULTI-MATERIALS	★★★★	298.250.20	70
250	25,4 (+20)	40	2,0	1,4	2°	8° ATB	MULTI-MATERIALS	★★★★	298.250.40	70
254	30	48	2,4	1,8	-5° Neg.	15° ATB	WOOD	★★★★★	294.048.10M	25
254	30	60	2,4	1,8	-5° Neg.	15° ATB	WOOD	★★★★★	294.060.10M	29
254	30	60	2,2	1,8	0°	8° FWF	METAL & STEEL	★★★★	226.060.10M	60
254	30	80	3,2	2,5	-6° Neg.	TCG	NON-FERROUS	★★★★★	297.081.10M	55
254	15,87	72	2,2	1,8	0°	10° FWF	METAL & STEEL	★★★★	226.572.10	62
254	15,87	48	2,2	1,8	0°	8° FWF	METAL & STEEL	★★★★	226.048.10	61
254	15,87	60	2,2	1,8	0°	8° FWF	METAL & STEEL	★★★★	226.060.10	60
260	30	28	2,8	1,8	20°	10° ATB	WOOD	★★★★	290.260.28M	22
260	30	48	2,8	1,8	15°	10° ATB	WOOD	★★★★	285.048.11M	26
260	30	60	2,5	1,8	-5° Neg.	10° ATB	WOOD	★★★★★	285.860.11M	28
260	30	60	2,8	1,8	10°	15° ATB	WOOD	★★★★	285.060.11M	30
260	30	60	2,5	1,8	-5° Neg.	15° ATB	WOOD	★★★★	294.060.11M	30
260	30	64	2,5	1,8	-3° Neg.	TCG	WOOD	★★★★	281.065.11M	47
260	30	80	2,5	1,8	-5° Neg.	15° ATB	WOOD	★★★★	294.080.11M	36
260	30	80	3,2	2,5	-6° Neg.	TCG	NON-FERROUS	★★★★★	297.080.11M	55
270	30	28	2,8	1,8	20°	10° ATB	WOOD	★★★★	290.270.28M	22
270	30	42	2,8	1,8	15°	10° ATB	WOOD	★★★★	291.270.42M	26
275	20	42	3,2	2,2	15°	10° ATB	WOOD	★★★★★	285.042.11H	25
275	32	0	2,5	-	-	Not Sharpened	METAL & STEEL	-	227.275P	59
275	32	140	2,5	-	-	C/HZ	METAL & STEEL	-	227.275.140P	58
275	32	220	2,5	-	-	BW	METAL & STEEL	-	227.275.220P	59
275	32	220	2,0	-	-	BW	METAL & STEEL	-	227.275.722P	59
275	32	220	2,5	-	-	BW	METAL & STEEL	-	227.275.720P	59
280	30	64	2,8	1,8	10°	15° ATB	WOOD	★★★★★	295.064.11M	29
280	30	64	3,2	2,5	-6° Neg.	TCG	NON-FERROUS	★★★★★	297.064.11M	55
300	20	48	3,2	2,2	15°	10° ATB	WOOD	★★★★★	285.048.12H	25
300	30	20	2,8	1,8	15°	5° ATB	WOOD	★★★★	286.020.12M	10

D mm	B mm	Z	K mm	P mm	α	β	MATERIALS APPLICATION	PERFORMANCE	ORDER NO.	PAGE
300	30	20	2,4	1,8	12°	TCG	MULTI-MATERIALS	★★★	236.300.20M	13
300	30	24	3,2	2,2	20°	10° ATB	WOOD	★★★★★	293.024.12M	21
300	30	24	2,6	1,8	22°	10° ATB + 8° Shear	WOOD	★★★★	271.300.24M	23
300	30	28	3,2	2,2	18°	10° ATB	WOOD	★★★★★	278.028.12M	19
300	30	36	3,2	2,2	15°	10° ATB	WOOD	★★★★★	285.036.12M	25
300	30	44	2,5	2,0	10°	HR	MULTI-MATERIALS	★★★★★	235.300.44M	53
300	30	48	3,2	2,2	15°	10° ATB	WOOD	★★★★★	286.048.12M	10
300	30	48	3,2	2,2	5°	10° ATB	WOOD	★★★★★	285.648.12M	24
300	30	48	3,2	2,2	5°	10° ATB	WOOD	★★★★★	285.048.12M	25
300	30	48	2,6	1,8	18°	10° ATB + 8° Shear	WOOD	★★★★	271.300.48M	27
300	30	60	3,2	2,2	15°	10° ATB	WOOD	★★★★★	285.060.12M	29
300	30	60	4,4	3,2	16°	TCG	WOOD	★★★★★	282.060.12M	48
300	30	60	4,4	3,2	15°	TCG	WOOD	★★★★★	282.300.60M	49
300	30	60	3,2	2,2	10°	TCG	WOOD	★★★★★	237.060.12M	52
300	30	72	3,2	2,2	10°	15° ATB	WOOD	★★★★★	285.672.12M	28
300	30	72	3,2	2,2	10°	15° ATB	WOOD	★★★★★	285.072.12M	29
300	30	72	2,6	1,8	15°	10° ATB + 8° Shear	WOOD	★★★★	272.300.72M	31
300	30	72	3,2	2,2	10°	TCG	WOOD	★★★★★	281.672.12M	42
300	30	72	3,2	2,2	10°	TCG	WOOD	★★★★★	281.072.12M	43
300	30	72	3,2	2,2	-3° Neg.	FFT	WOOD	★★★★★	281.073.12M	45
300	30	80	2,2	1,8	0°	10° FWF	METAL & STEEL	★★★★★	226.580.12M	62
300	30	84	3,2	2,5	0°	MTCG	MULTI-MATERIALS	★★★★★	223.084.12M	63
300	30	96	3,2	2,2	5°	15° ATB	WOOD	★★★★★	285.696.12M	32
300	30	96	3,2	2,2	5°	15° ATB	WOOD	★★★★★	285.096.12M	33
300	30	96	2,6	1,8	12°	10° ATB + 8° Shear	WOOD	★★★★	273.300.96M	37
300	30	96	3,2	2,2	2°	38° Hi-ATB	WOOD	★★★★★	283.696.12M	38
300	30	96	3,2	2,2	2°	40° Hi-ATB	WOOD	★★★★★	283.096.12M	39
300	30	96	3,0	2,5	10°	20° ATB	WOOD	★★★★★	285.596.12M	40
300	30	96	3,2	2,2	5°	TCG	WOOD	★★★★★	281.696.12M	42
300	30	96	3,2	2,2	10°	TCG	WOOD	★★★★★	281.096.12M	43
300	30	96	3,2	2,2	10°	FFT	WOOD	★★★★★	295.096.12M	44
300	30	96	3,2	2,2	-3° Neg.	TCG	WOOD	★★★★★	281.697.12M	46
300	30	96	3,2	2,2	15°	TCG	WOOD	★★★★★	237.096.12M	52
300	30	96	3,2	2,5	-6° Neg.	TCG	NON-FERROUS	★★★★★	297.096.12M	55
300	30	96	2,8	2,0	-6° Neg.	TCG	NON-FERROUS	★★★★	276.300.96M	57
300	30	96	2,8	2,2	-3° Neg.	MATB	MULTI-MATERIALS	★★★★★	222.096.12M	63
300	30	100	3,2	2,2	15°	1° FLAT + 4° ATB	WOOD	★★★★★	274.100.12M	41
300	30	24+4	3,2	2,2	18°	10° ATB	WOOD	★★★★★	279.024.12M	18
300	30	24+4	4,0	2,8	18°	10° ATB	WOOD	★★★★★	277.024.12M	17
300	32	0	2,5	-	-	Not Sharpened	METAL & STEEL	-	227.300P	59
300	32	96	3,2	2,5	6°	TCG	NON-FERROUS	★★★★★	284.096.12P	54
300	32	96	3,2	2,5	-6° Neg.	TCG	NON-FERROUS	★★★★★	297.096.12P	55
300	32	160	2,5	-	-	C/HZ	METAL & STEEL	-	227.300.160P	58
300	32	220	2,5	-	-	BW	METAL & STEEL	-	227.300.220P	59
300	32	220	2,0	-	-	BW	METAL & STEEL	-	227.300.722P	59
300	32	220	2,5	-	-	BW	METAL & STEEL	-	227.300.720P	59
300	35	24	3,2	2,2	20°	10° ATB	WOOD	★★★★★	293.024.12R	21
300	35	48	3,2	2,2	15°	10° ATB	WOOD	★★★★★	285.048.12R	25
300	35	72	3,2	2,2	10°	15° ATB	WOOD	★★★★★	285.072.12R	29
300	35	96	3,2	2,2	5°	15° ATB	WOOD	★★★★★	285.096.12R	33
300	50	48	4,3-5,5	3,2	10°	CO+FLAT	WOOD	★★★★★	288.300.48T	51
300	60	24+4	3,2	2,2	18°	10° ATB	WOOD	★★★★★	279.024.12U	18
300	65	72	4,3-5,5	3,2	10°	CO+FLAT	WOOD	★★★★★	288.300.72J	51
300	70	28	3,2	2,2	18°	10° ATB	WOOD	★★★★★	278.028.12V	19
300	70	24+4	2,7	1,8	18°	10° ATB	WOOD	★★★★★	280.024.12V	16
300	70	24+4	3,2	2,2	18°	10° ATB	WOOD	★★★★★	279.024.12V	18
300	70	24+4	4,0	2,8	18°	10° ATB	WOOD	★★★★★	277.024.12V	17

Saw Blade Index

D mm	B mm	Z	K mm	P mm	α	β	MATERIALS APPLICATION	PERFORMANCE	ORDER NO.	PAGE
300	75	60	4,4	3,2	16°	TCG	WOOD	★★★★	282.060.12X	48
300	80	60	4,4	3,2	16°	TCG	WOOD	★★★★	282.060.12W	48
300	80	60	4,4	3,2	16°	TCG	WOOD	★★★★★	282.300.60W	49
300	80	24+4	2,7	1,8	18°	10° ATB	WOOD	★★★★	280.024.12W	16
300	80	24+4	3,2	2,2	18°	10° ATB	WOOD	★★★★	279.024.12W	18
300	80	24+4	4,0	2,8	18°	10° ATB	WOOD	★★★★	277.024.12W	17
303	30	60	3,2	2,2	-6° Neg.	HDF	WOOD	★★★★	287.061.12M	34
303	30	60	3,2	2,2	10°	HDF	WOOD	★★★★	287.060.12M	35
305	30	28	2,8	1,8	20°	10° ATB	WOOD	★★★★★	293.028.22M	21
305	30	48	2,6	1,8	-5° Neg.	10° ATB	WOOD	★★★	271.305.48M	27
305	30	54	2,8	1,8	-5° Neg.	15° ATB	WOOD	★★★★★	294.054.22M	25
305	30	72	3,2	2,2	10°	15° ATB	WOOD	★★★★★	285.072.22M	29
305	30	72	3,2	2,2	-5° Neg.	15° ATB	WOOD	★★★★★	294.072.22M	29
305	30	72	2,6	1,8	-5° Neg.	10° ATB	WOOD	★★★	272.305.72M	31
305	30	80	2,2	1,8	0°	8° FWF	METAL & STEEL	★★★★	226.080.12M	60
305	30	96	3,2	2,5	-6° Neg.	TCG	NON-FERROUS	★★★★★	297.096.13M	55
305	30	96	2,8	2,0	-6° Neg.	TCG	NON-FERROUS	★★★	276.305.96M	57
305	25,4	80	2,2	1,8	0°	10° FWF	METAL & STEEL	★★★★	226.580.12	62
305	25,4	60	2,2	1,8	0°	8° FWF	METAL & STEEL	★★★★	226.060.12	61
305	25,4	80	2,2	1,8	0°	8° FWF	METAL & STEEL	★★★★	226.080.12	60
315	30	24	3,2	2,2	15°	5° ATB	WOOD	★★★★	286.024.13M	10
315	30	28	3,2	2,2	20°	10° ATB	WOOD	★★★★★	293.028.12M	21
315	30	36	3,2	2,2	15°	5° ATB	WOOD	★★★★★	285.036.13M	21
315	30	54	3,2	2,2	15°	10° ATB	WOOD	★★★★★	294.054.12M	25
315	30	54	2,6	1,8	-5° Neg.	10° ATB	WOOD	★★★	271.315.54M	27
315	30	72	3,2	2,2	15°	10° ATB	WOOD	★★★★★	285.072.13M	29
315	30	96	3,2	2,5	-6° Neg.	TCG	NON-FERROUS	★★★★★	297.096.23M	55
315	32	0	2,5	-	-	Not Sharpened	METAL & STEEL	-	227.315P	59
315	32	160	2,5	-	-	C/HZ	METAL & STEEL	-	227.315.160P	58
315	32	240	2,5	-	-	BW	METAL & STEEL	-	227.315.240P	59
315	32	240	2,5	-	-	BW	METAL & STEEL	-	227.315.740P	59
320	65	60	4,4	3,2	16°	TCG	WOOD	★★★★	Y282.060.13J	48
320	65	60	4,4	3,2	15°	TCG	WOOD	★★★★★	282.320.60J	49
320	65	72	4,4	3,2	16°	TCG	WOOD	★★★★	282.072.13J	48
320	65	72	4,4	3,2	15°	TCG	WOOD	★★★★★	282.320.72J	49
330	30	96	3,6	3,0	-6° Neg.	TCG	NON-FERROUS	★★★★★	297.096.33M	55
330	32	96	3,6	3,0	-6° Neg.	TCG	NON-FERROUS	★★★★★	297.096.33P	55
350	30	24	3,2	2,2	15°	5° ATB	WOOD	★★★★★	286.024.14M	10
350	30	28	3,5	2,5	20°	10° ATB	WOOD	★★★★★	293.028.14M	21
350	30	36	3,5	2,5	18°	10° ATB	WOOD	★★★★★	278.036.14M	19
350	30	54	3,5	2,5	5°	10° ATB	WOOD	★★★★★	285.654.14M	24
350	30	54	3,5	2,5	5°	10° ATB	WOOD	★★★★★	285.054.14M	25
350	30	54	4,4	3,2	16°	TCG	WOOD	★★★★	282.054.14M	48
350	30	72	3,5	2,5	15°	10° ATB	WOOD	★★★★★	285.072.14M	29
350	30	72	4,4	3,2	16°	TCG	WOOD	★★★★	282.072.14M	48
350	30	72	4,4	3,2	15°	TCG	WOOD	★★★★★	282.350.72M	49
350	30	72	3,5	2,4	15°	TCG	WOOD	★★★★★	237.072.14M	52
350	30	84	3,5	2,5	10°	15° ATB	WOOD	★★★★★	285.684.14M	28
350	30	84	3,5	2,5	10°	15° ATB	WOOD	★★★★★	285.084.14M	29
350	30	84	3,5	2,5	10°	TCG	WOOD	★★★★★	281.684.14M	42
350	30	84	3,5	2,5	10°	TCG	WOOD	★★★★★	281.084.14M	43
350	30	108	3,5	2,5	5°	15° ATB	WOOD	★★★★★	285.708.14M	32
350	30	108	3,5	2,5	5°	15° ATB	WOOD	★★★★★	285.108.14M	33
350	30	108	3,5	2,5	5°	40° HI-ATB	WOOD	★★★★★	283.108.14M	39
350	30	108	3,5	2,5	5°	TCG	WOOD	★★★★★	281.708.14M	42
350	30	108	3,5	2,5	10°	TCG	WOOD	★★★★★	281.108.14M	43
350	30	108	3,5	2,5	10°	FFT	WOOD	★★★★★	295.108.14M	44

Saw Blade Index



D mm	B mm	Z	K mm	P mm	α	β	MATERIALS APPLICATION	PERFORMANCE	ORDER NO.	PAGE
350	30	108	3,5	2,5	10°	TCG	WOOD	★★★★	281.108.14M	48
350	30	108	3,6	3,0	-6° Neg.	TCG	NON-FERROUS	★★★★★	297.108.14M	55
350	30	24+6	4,2	2,8	18°	10° ATB	WOOD	★★★★	277.024.14M	17
350	30	28+4	3,5	2,5	18°	10° ATB	WOOD	★★★★	279.028.14M	18
350	32	0	2,5	-	-	Not Sharpened	METAL & STEEL	-	227.350P	59
350	32	84	3,6	3,0	6°	TCG	NON-FERROUS	★★★★★	284.092.14P	54
350	32	108	3,6	3,0	6°	TCG	NON-FERROUS	★★★★★	284.108.14P	54
350	32	108	3,6	3,0	-6° Neg.	TCG	NON-FERROUS	★★★★★	297.108.14P	55
350	32	180	2,5	-	-	C/HZ	METAL & STEEL	-	227.350.180P	58
350	32	280	2,5	-	-	BW	METAL & STEEL	-	227.350.280P	59
350	32	280	2,5	-	-	BW	METAL & STEEL	-	227.350.780P	59
350	35	28	3,5	2,5	20°	10° ATB	WOOD	★★★★★	293.028.14R	21
350	35	54	3,5	2,5	15°	10° ATB	WOOD	★★★★★	285.054.14R	25
350	35	84	3,5	2,5	10°	15° ATB	WOOD	★★★★★	285.084.14R	29
350	35	108	3,5	2,5	5°	15° ATB	WOOD	★★★★★	285.108.14R	33
350	50	72	4,4	3,2	16°	TCG	WOOD	★★★★	282.072.14T	48
350	60	72	4,4	3,2	16°	TCG	WOOD	★★★★	Y282.072.14U	48
350	60	72	4,4	3,2	15°	TCG	WOOD	★★★★★	282.350.72U	49
350	60	28+4	3,5	2,5	18°	10° ATB	WOOD	★★★★	279.028.14U	18
350	70	36	3,5	2,5	18°	10° ATB	WOOD	★★★★★	278.036.14V	19
350	70	24+6	4,2	2,8	18°	10° ATB	WOOD	★★★★	277.024.14V	17
350	70	28+4	3,5	2,5	18°	10° ATB	WOOD	★★★★	279.028.14V	18
350	75	54	4,4	3,2	16°	TCG	WOOD	★★★★	282.054.14X	48
350	75	72	4,4	3,2	16°	TCG	WOOD	★★★★	282.072.14X	48
350	75	72	4,4	3,2	15°	TCG	WOOD	★★★★★	282.350.72X	49
350	80	54	4,4	3,2	16°	TCG	WOOD	★★★★	282.054.14W	48
350	80	72	4,4	3,2	16°	TCG	WOOD	★★★★	282.072.14W	48
350	80	72	4,4	3,2	16°	TCG	WOOD	★★★★★	282.350.72W	49
350	80	28+4	3,5	2,5	18°	10° ATB	WOOD	★★★★	279.028.14W	18
355	30	72	4,4	3,2	16°	TCG	WOOD	★★★★	S282.03556	48
355	30	90	2,2	1,8	0°	8° FWF	METAL & STEEL	★★★★	226.090.14M	60
355	30	90	2,2	1,8	0°	10° FWF	METAL & STEEL	★★★★	226.590.14M	62
355	65	72	4,4	3,2	16°	TCG	WOOD	★★★★	282.072.14J2	48
355	65	72	4,4	3,2	16°	TCG	WOOD	★★★★★	282.355.72J	49
355	80	72	4,4	3,2	10°	TCG	WOOD	★★★★	282.072.14W2	48
355	25,4	72	2,2	1,8	0°	8° FWF	METAL & STEEL	★★★★	226.072.14	61
355	25,4	90	2,2	1,8	0°	8° FWF	METAL & STEEL	★★★★	226.090.14	60
355	25,4	90	2,2	1,8	0°	10° FWF	METAL & STEEL	★★★★	226.590.14	62
380	60	72	4,4	3,2	15°	TCG	WOOD	★★★★	282.072.15U2	48
380	60	72	4,8	3,5	16°	TCG	WOOD	★★★★	282.072.15U	48
380	60	72	4,4	3,2	15°	TCG	WOOD	★★★★★	282.380.72U2	49
380	60	72	4,8	3,5	15°	TCG	WOOD	★★★★★	282.380.72U	49
380	80	72	4,4	3,2	16°	TCG	WOOD	★★★★	282.072.15W	48
380	80	72	4,4	3,2	16°	TCG	WOOD	★★★★★	282.380.72W	49
400	30	28	3,2	2,2	15°	5° ATB	WOOD	★★★★★	286.028.16M	10
400	30	36	3,5	2,5	20°	10° ATB	WOOD	★★★★★	285.036.16M	21
400	30	48	3,5	2,5	20°	10° ATB	WOOD	★★★★★	285.048.16M	25
400	30	60	3,5	2,5	10°	15° ATB	WOOD	★★★★★	285.660.16M	24
400	30	60	3,5	2,5	10°	15° ATB	WOOD	★★★★★	285.060.16M	25
400	30	60	4,4	3,2	16°	TCG	WOOD	★★★★	282.060.16M	48
400	30	72	4,4	3,2	16°	TCG	WOOD	★★★★	282.072.16M	48
400	30	72	4,4	3,2	15°	TCG	WOOD	★★★★★	282.400.72M	49
400	30	96	3,5	2,5	10°	15° ATB	WOOD	★★★★★	285.696.16M	28
400	30	96	3,5	2,5	10°	15° ATB	WOOD	★★★★★	285.096.16M	29
400	30	120	3,5	2,5	10°	15° ATB	WOOD	★★★★★	285.120.16M	33
400	30	120	4,0	3,2	-6° Neg.	TCG	NON-FERROUS	★★★★★	297.120.16M	55
400	30	28+6	4,0	2,8	18°	10° ATB	WOOD	★★★★	279.028.16M	18

Saw Blade Index

D mm	B mm	Z	K mm	P mm	α	β	MATERIALS APPLICATION	PERFORMANCE	ORDER NO.	PAGE
400	32	96	4,0	3,2	6°	TCG	NON-FERROUS	★★★★★	284.096.16P	54
400	32	96	4,0	3,2	-6° Neg.	TCG	NON-FERROUS	★★★★★	297.108.16P	55
400	32	120	4,0	3,2	-6° Neg.	TCG	NON-FERROUS	★★★★★	297.120.16P	55
400	60	72	4,4	3,2	16°	TCG	WOOD	★★★★	282.072.16U	48
400	70	28+6	4,0	2,8	18°	10° ATB	WOOD	★★★★	279.028.16V	18
400	75	60	4,4	3,2	16°	TCG	WOOD	★★★★	282.060.16X	48
400	75	72	4,4	3,2	16°	TCG	WOOD	★★★★	282.072.16X	48
400	75	72	4,4	3,2	16°	TCG	WOOD	★★★★★	282.400.72X	49
400	80	60	4,4	3,2	16°	TCG	WOOD	★★★★	282.060.16W	48
400	80	72	4,4	3,2	16°	TCG	WOOD	★★★★	282.072.16W	48
400	80	72	4,4	3,2	15°	TCG	WOOD	★★★★★	282.400.72W	49
420	32	96	3,8	3,2	6°	TCG	NON-FERROUS	★★★★★	284.096.17P	54
420	80	72	4,4	3,2	15°	TCG	WOOD	★★★★	282.072.17W	48
430	65	72	4,4	3,2	16°	TCG	WOOD	★★★★	Y282.072.17J	48
430	75	72	4,4	3,2	16°	TCG	WOOD	★★★★	282.072.17X	48
430	80	72	4,4	3,2	16°	TCG	WOOD	★★★★	282.072.17W2	48
450	30	32	3,8	2,8	15°	5° ATB	WOOD	★★★★★	286.032.18M	10
450	30	36	3,8	2,8	20°	10° ATB	WOOD	★★★★★	285.036.18M	21
450	30	54	3,8	2,8	15°	15° ATB	WOOD	★★★★★	285.054.18M	25
450	30	66	3,8	2,8	10°	15° ATB	WOOD	★★★★★	285.066.18M	29
450	30	72	4,4	3,2	16°	TCG	WOOD	★★★★	Y282.072.18M2	48
450	30	96	4,2	3,5	-6° Neg.	TCG	NON-FERROUS	★★★★★	297.108.18M	55
450	30	108	4,2	3,5	6°	TCG	NON-FERROUS	★★★★★	284.108.18M	54
450	30	120	4,2	3,5	-6° Neg.	TCG	NON-FERROUS	★★★★★	Y297.140.18M	55
450	32	96	4,2	3,5	-6° Neg.	TCG	NON-FERROUS	★★★★★	297.108.18P	55
450	32	108	4,2	3,5	6°	TCG	NON-FERROUS	★★★★★	284.108.18P	54
450	32	120	4,2	3,5	-6° Neg.	TCG	NON-FERROUS	★★★★★	297.120.18P	55
450	60	72	4,8	3,5	16°	TCG	WOOD	★★★★	282.072.18U	48
450	60	72	4,8	3,5	15°	TCG	WOOD	★★★★★	282.450.72U	49
450	80	72	4,8	3,5	16°	TCG	WOOD	★★★★	282.072.18W2	48
500	30	36	3,8	2,8	15°	5° ATB	WOOD	★★★★★	286.036.20M	10
500	30	44	4,0	2,8	20°	10° ATB	WOOD	★★★★★	285.044.20M	21
500	30	60	3,8	2,8	15°	15° ATB	WOOD	★★★★★	285.060.20M	25
500	30	72	3,8	2,8	10°	15° ATB	WOOD	★★★★★	285.072.20M	29
500	30	120	4,3	3,5	10°	TCG	NON-FERROUS	★★★★★	284.120.20M	54
500	30	120	4,3	3,5	-6° Neg.	TCG	NON-FERROUS	★★★★★	297.120.20M	55
500	32	120	4,3	3,5	10°	TCG	NON-FERROUS	★★★★★	284.120.20P	54
500	32	120	4,3	3,5	-6° Neg.	TCG	NON-FERROUS	★★★★★	297.120.20P	55
500	60	72	4,8	3,5	16°	TCG	WOOD	★★★★	282.072.20U	48
550	30	40	4,2	3,2	15°	5° ATB	WOOD	★★★★★	286.040.22M	10
550	30	60	4,2	3,2	10°	15° ATB	WOOD	★★★★★	285.060.22M	25
550	30	96	4,2	3,2	10°	15° ATB	WOOD	★★★★★	285.096.22M	29
600	30	40	4,2	3,2	15°	5° ATB	WOOD	★★★★★	286.040.24M	10
600	30	66	4,2	3,2	10°	15° ATB	WOOD	★★★★★	285.066.24M	25
700	30	46	4,4	3,2	15°	5° ATB	WOOD	★★★★★	286.046.28M	10
700	30	72	4,4	3,2	10°	15° ATB	WOOD	★★★★★	285.072.28M	25

www.cmtorangetools.com



C.M.T. UTENSILI S.p.A.

Via della Meccanica, sn
61122 Pesaro (PU) - Italia

Tel. +39 0721 48571

Fax +39 0721 481021

info@cmtorangetools.com



Download this Catalogue



03.60.3006

15K0124